



TechNews

Spring 2012 | Volume 5 | Issue 1



INFINITI

| Drive Belts

| Driver Assistance Systems

| Body Basics

| VVEL System

| Wheel Bearings Service

| Dealer Listing



*Brought to you by your local Wholesale Mechanical
and Collision Repair Network Dealers*



SHIFT the way you move



Speed Up Your Cycle Time. Not Your Re-Cycle Time.

TRUST THE ORIGINAL. GENUINE NISSAN PARTS.

Cheap aftermarket parts are expensive. Every time you re-fit, re-sand or re-finish an ill-fitting part it's costing you money. In order to maximize profits, you need to maximize the use of every available hour of labor.

Don't settle for anything less than Nissan Original Equipment replacement parts. They provide the same fit and finish as the original part, potentially speeding up repair cycle-time. Ultimately providing a higher level of customer satisfaction and profit to your bottom line.



Your Rewards are Ready!

Nissan and Advantage Awards offer you the most comprehensive online reward catalog available in the repair industry. Parts Reward Points are issued to enrolled repair shops on qualifying Genuine Parts purchases from participating Nissan and Infiniti dealers*.

*To enroll your shop visit nissanpartsrewards.com or infinitipartsrewards.com.

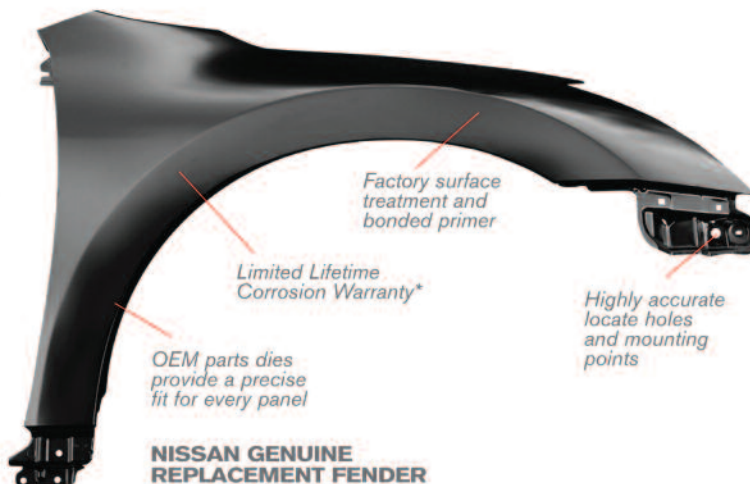

Factory surface treatment and bonded primer

*Limited Lifetime Corrosion Warranty**

OEM parts dies provide a precise fit for every panel

Highly accurate locate holes and mounting points

NISSAN GENUINE REPLACEMENT FENDER

*Outer sheet metal panels are warranted as long as your customer owns their vehicle.



Nissan & Infiniti Tech News is a publication of Nissan North America. No part of this newsletter may be reproduced without the express written permission of Nissan North America.

Group Publisher

Christopher M. Ayers Jr.
cayers@automotivedatamedia.com

Editorial Director

Bob Freudenberger
bfreud@automotivedatamedia.com

Managing Editor

Tom Nash
tnash@automotivedatamedia.com

Contributing Editors

Bob Chabot
bchabot@automotivedatamedia.com

Paul Cortes
pcortes@automotivedatamedia.com

Phil Fournier
ffournier@automotivedatamedia.com

Christian Strohm
cstrohm@automotivedatamedia.com

Art Director

Jef Sturm
jsturm@automotivedatamedia.com

**Nissan North America
Project Manager**

Don Meier
don.meier@nissan-usa.com

**Nissan North America
Technical Content Advisors**

Edwin J. Hibma
ed.hibma@nissan-usa.com

James Von Ehr
james.vonehr@nissan-usa.com

**Editorial and
Circulation Offices:**

134B River Road
Montague, NJ 07827
Phone: 330.620.3929
Website: www.mastertechmag.com

Caution: Vehicle servicing performed by untrained persons could result in serious injury to those persons or others. Information contained in this publication is intended for use by trained, professional auto repair technicians ONLY. This information is provided to inform these technicians of conditions which may occur in some vehicles or to provide information which could assist them in proper servicing of these vehicles.

Properly trained technicians have the equipment, tools, safety instructions, and know-how to perform repairs correctly and safely. If a condition is described, DO NOT assume that a topic covered in these pages automatically applies to your vehicle or that your vehicle has that condition.

Contents

Features



04 | Beyond the Belt

The automotive accessory drive belt is a staple maintenance item. Let's take a look at the types of drive belts, material structure, adjusting tension, diagnosing problems, and a few tech tips for working with them on a daily basis.



12 | Advanced Driver Assistance Systems (ADAS)

Lane Departure Prevention, Intelligent Cruise Control, and other advanced controls are Nissan's newest line of features in some vehicles.



18 | Body Basics Premier Products

In this installment, we'll look at the benefits of using Nissan-approved body alignment equipment and associated tools, bonding and mating products, surface prep, paint and finish products and tools.



22 | VVEL Systems

Here's an overview of Nissan's Variable Valve Event and Lift system. We'll look at which Nissan and Infiniti vehicles are equipped with VVEL, how the system functions, and maintenance considerations.



26 | Wheel Bearing Diagnosis & Service

Here are the basics of wheel bearing diagnosis and service, as well as some old-time wisdom and techniques that used to be a little more commonplace prior to the information age.

Department

| 27 Nissan & Infiniti Dealer Listings

| Beyond the Belt



The automotive accessory drive belt is a staple maintenance item. Let's take a look at the types of drive belts, material structure, adjusting tension, diagnosing problems, and a few tech tips for working with them on a daily basis.

Everyone knows about drive belts. Even customers will often attempt to diagnose their own cars, claiming that their Altima's "fan belt" is making noise. Of course, that car has an electric cooling fan, but the sentiment is what matters most. Drive belts have been employed since the vintage vehicles from around World War I, so it's no real wonder that people are familiar with them. Yet, how familiar are we really with the details surrounding a drive belt? We'll shed some light on the history of the drive belt: its evolution from one shape to another; the chemical engineering involved in its materials; and the proper way to inspect and service it.

Before we get into the nitty-gritty of the drive belt, let's talk about practical information that may help your daily work. The purpose of a drive belt is to attach two pulleys and for one to drive the other using friction. Anything that prevents or reduces belt friction will also prevent the transmission of power from the crank pulley to the accessory pulley(s). Drive belt service should include checking tension, material wear or contamination, pulley alignment, and bearing roughness.

Types of Drive Belts

Let's address the different styles of drive belts you will encounter when working on Nissan vehicles. All drive belts are designed to do the same thing: transmit power from the crank shaft to the accessories. Each drive belt will be made up of three primary components:

1. The heat and oil resistant coating called the cover.
2. The stability and strength enhancing fiber band called the tension member.
3. The softest rubber, friction-providing compression section.

Until somewhat recently, the most common drive belt design was the V-belt. It is thin, using a trapezoidal compression section that wedges between the sloped sides of a deep pulley. However, this design has a few inherent problems that result in its comparatively short lifespan. Like a pencil eraser, rubber will scrub off over time from the sides of the trapezoidal compression section. Without automatic tensioning, this causes the belt to elongate and lose friction strength requiring periodic adjustment. The bottom of

the belt is not providing the friction, it's the sides only. So, if the belt ever bottoms out, it's beyond its service life or too small for the application. Also, the V-belt requires a large, deep pulley for lots of contact area with the friction wedge. This can limit engine layout options.

The V-belt design was more or less multiplied and miniaturized to create the most common type of belt in modern cars called the multi-rib belt. This ribbed belt has many benefits over the V-belt. First, it eliminates the need for deep pulleys, which allow for better engine layout and design possibilities for compact cars. Second, the method of generating friction no longer scrubs significant amounts of rubber from the compression section. Additionally, since the belt is flatter and wider, the backside surface can be used to power accessories that may not command a significant load.

If there's only one belt to power all the accessories, it's a serpentine drive belt. Most similar in design to the standard multi-rib belt, the serpentine belt is often engineered in a way to resist the wear introduced by its circuitous route. The backing cover is reinforced on a serpentine belt to resist wear and abrasion from idler bearings or pulleys that use the back side for friction instead of the ribbed side. Nevertheless, a serpentine belt does not last quite as long as a standard multi-rib belt, so be certain to check periodically using the tips below. Just like its namesake, the snake, it bends both ways.



Notice the trapezoidal shape of the V-belt. This quality Nissan belt also has extra material in the compression section to improve longevity.



This serpentine belt has a reinforced backing seen in the white threads, and it has additional material for powering pulleys using the non-ribbed side.

Properly Checking and Setting Belt Tension

With the different types of belt designs in mind, let's explore how to check and set their tension properly.

There's no way around it: checking belt tension requires tools. Nissan has an official gauge designed to check belt tension (P/N BT-3373-F), but any tension gauge will work. You should check and set the belt tension when the vehicle is cold. The gauge measures the amount of deflection in the belt with a controlled force applied. For instance, the 2003 Pathfinder A/C belt should deflect 12mm with 98 Nm of force applied. Using a different type of tool, you may be able to measure the amount of force it requires to deflect the specified amount. Either way, the proper tension or deflection measurement can be compared to a table in the service manual. Bear in mind that there is no "general rule" for tension because different belt styles, thicknesses and lengths will all deflect a different amount.

A newer drive belt will have a different published deflection or tension specification than an older belt. Consult the factory manual to determine the appropriate tension for each particular vehicle. This is because new belts will stretch, or break in, and Nissan accounts for that behavior.



This same adjuster pulley is available with and without the mounting bracket. At the top of the adjuster nut is a friendly reminder to retighten the belt after installation.



This spring-loaded automatic belt tensioner is actually the third version of the original (the last five digits began as EA200, then EA20A). A major benefit of buying Genuine Nissan OE parts is that they are constantly updating and improving designs. Aftermarket parts may be copying the design of the previous tensioners.

On many Nissan vehicles, belt tension adjustment is performed by physically manipulating a bolt to move an idler pulley. On other models, the accessory itself must be loosened and relocated to achieve the same effect.

Both methods require periodic manual adjustment. If the belt is automatically tensioned with a hydraulic or spring-loaded assembly, there will be markings on the device to indicate whether the belt has stretched beyond service life. Another major benefit is that no periodic adjustment is necessary.

When installing a drive belt, you should inspect the adjuster for play, rust, the presence of oil, proper alignment, as well as if the belt bounces or slaps while running. For automatic tensioners, check for hydraulic leaks and spring tension to determine whether the unit should also be replaced. If a spring tensioner can be moved by hand, it's likely worn out.

A drive belt with too much tension applied may cause the bearing to whine when the vehicle is on. Do not get in the habit of over-tensioning belts because "it'll just get looser." While a belt may stretch a little after the initial installation and setting of the tension, this is no reason to cause damage to pulleys and accessories in the meantime. Set the initial tension, run the engine for five minutes at 2,000 rpm, then re-set the belt tension once and for all. If you used a Genuine Nissan OE quality belt, this should be the last time you see that car for a belt!

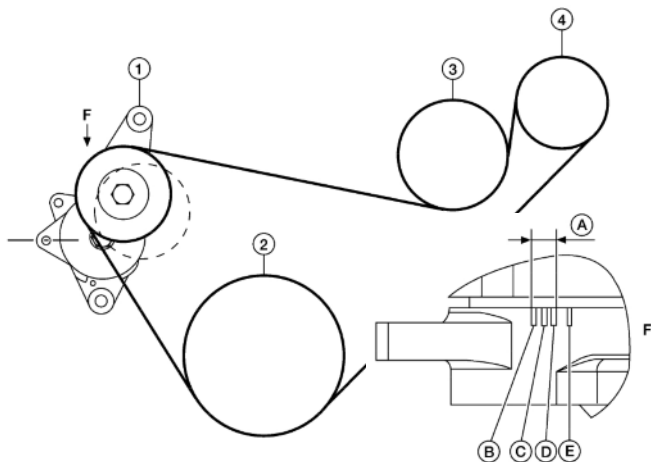

The auto belt tensioner (F) will have markings to determine whether a drive belt has stretched too much. The side view shows the markings, including acceptable range (A).

Inspecting for Belt Wear or Signs of Contamination

A visual inspection of belt wear and contamination is necessary. Minor cracking of a multi-rib belt does not necessarily mean it must be replaced. If the belt is off

the vehicle, bend it backwards and check if the cracks reach the backing band. If so, replace the belt. When the belt is on the car, rotate it so the ribs face upwards; if the belt is bad, the tension introduced should splay the cracks apart. A V-belt will lose material from its sides, which is harder to identify unless compared to a new belt. When setting a V-belt in the pulley, it should NOT touch the bottom of the pulley. The belt is designed to provide friction by being wedged in place like a dove-tail fitting, not by gripping the pulley bottom.

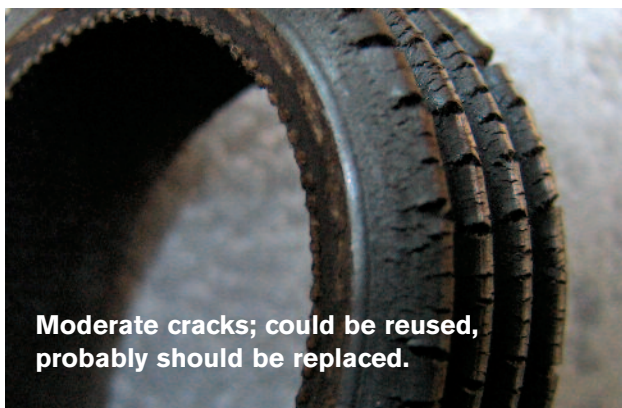

Nissan & Infiniti Drive Belts

If there is abnormal wear on the belt backing, verify that the course of the belt does not contact any cover or metal component. Many times, an out-of-place timing cover will contact a drive belt, causing noise and accelerating wear. Repair the initial source of contact first, then immediately replace any drive belt with backing wear. There isn't much "meat" on the back of a belt, and damage to this area can cause rapid belt failure.

Oil contamination from power steering fluid or an engine oil leak can shorten the lifespan of a drive belt. Even if the belt does not appear to be cracking or swelling, contact with oil will affect its internal chemical integrity. Identify and fix the source of oil leak first, then replace any contaminated drive belts. A splash of oil here or there, if cleaned off quickly, will not immediately ruin a modern drive belt whose external cover is engineered to resist compromise from oil. Contamination refers to consistent oil contact over a period of time.

Some drive belts may be noisy despite having proper tension, no visible cracks, and no oil contamination. The belt material is likely glazed. Glazing occurs when the belt surface heats up too much, which can be from initial over-tensioning, pulley bearing resistance, or just over time. As long as the belt retains tension, there is no action required due to glazing.

Identifying Drive Belt Pulley Problems

Some problems with the accessories can cause drive belt failure. If a vehicle's drive belt has broken or melted, you should suspect a seized accessory. With the belts off the car, check for binding or roughness of all the idlers and replace any that do not spin freely. Some accessories may also be the cause, so be sure to check A/C compressor clutch operation. Be careful, however, because many bearings will only misbehave when loaded. You may have to recheck for bearing noise with an automotive stethoscope after installing new belts.

Pulley alignment and play are often overlooked inspection items. If a drive belt wears prematurely, it could be that the pulleys are misaligned, creating additional internal load on the belt. With the drive belts off the engine, you can easily use a straight edge to confirm proper alignment.

A pulley bearing that has excessive free-play may also cause premature wear by stretching the belt too much laterally.

A special note about crank pulleys with harmonic

balancers: the rubber can deteriorate allowing the outer pulley ring to rotate with respect to the inner. This uncommon scenario can cause belt slip symptoms, or even belt failure.

The Right Belts

Finish the job correctly by installing Genuine Nissan OE drive belts. The specifications for tension are published using these belts in mind. They are also manu-

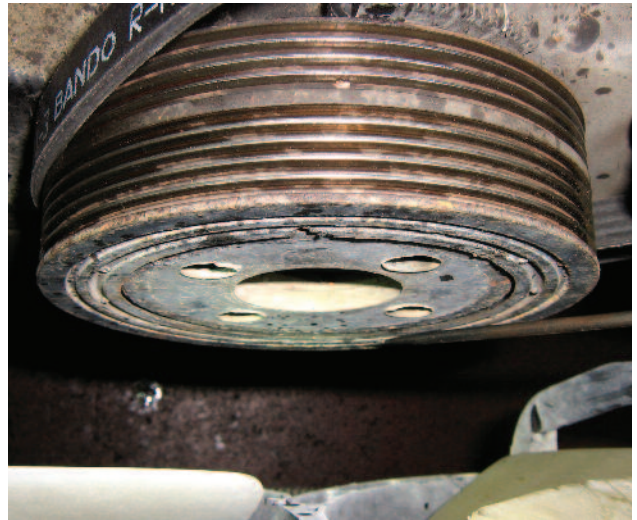

Perfectly normal harmonic balancer/crank pulley assembly, right?



No! The pointer has remained in the same position between the two images.

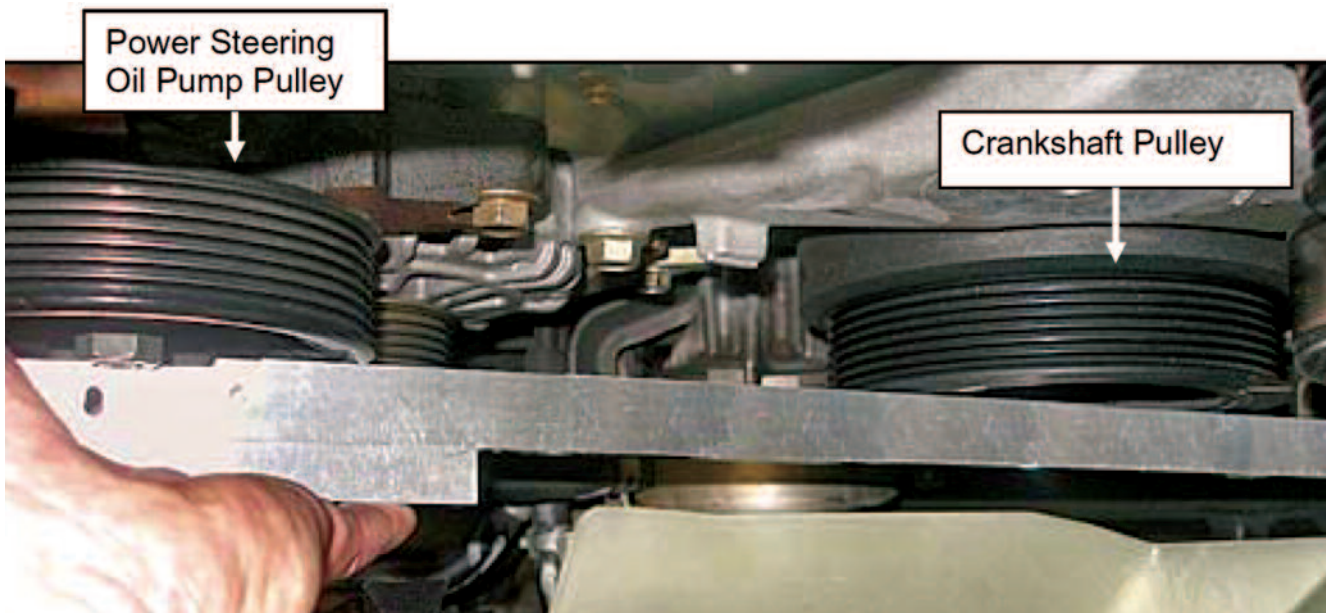

Check pulley alignment between the crankshaft pulley and the power steering pump using a straight edge.

factured with superior materials, able to resist oil and other solvents better than inferior drive belts. Their internal reinforcement structures are also better engineered, which prevents excessive stretching over time. Whenever you finish installing drive belts, and adjusting the tension cold, run the vehicle for approximately five minutes. After this initial conditioning, wait for the belts to cool before checking and readjusting belt tension. If you used a Nissan belt, this final tension should last the majority of the life of the belt. Using quality Nissan belts, you will have fewer customers come back to your shop for readjustment.

Chemistry – a Brief History of Rubber Polymers

Now we know not to let oil touch the belts, but why is that? We should begin with a bit of history and terminology. Drive belts aren't made of rubber, per se, because traditional natural rubber is made from the sap of a tree. Modern rubbers are actually synthetic blends derived from molecules found primarily in petroleum oil. There was great demand in the early 20th century to develop an alternative to the plant-derived, natural rubber. Thus began the creation of many different petroleum-derived polymers that could function like traditional rubber.

Without going overboard in the explanation, a polymer is a generic term from chemistry. Many things are polymers, some of them are man-made and some exist in nature. A polymer is formed from multiple monomers, which is another generic term for any molecule structure that can conjoin with a similar structure. For instance, we often hear about high fructose corn syrup, which is a polymer created from the naturally occurring monomer called glucose found in corn.

Nissan drive belts are primarily made from neoprene, a synthetic rubber, which has undergone one further chemical process called vulcanization. Vulcanizing a polymer will introduce substances called curatives, and that allows the manufacturer to control many qualities of the polymer. Just like engine oil additives, the mixture is unique and secret. We're not just talking about "how stretchy" the synthetic rubber is, but also how resistant to heat, solvents and oil. To give you a sense of the control the chemical engineer has, just imagine that a bowling ball can be made from neoprene using a different vulcanization technique.

So, when oil contacts a drive belt or other rubber polymer you can start to piece together why this is bad. A slow chemical reaction occurs where the oil molecules begin to compete for the curatives within the polymer. This effect causes the properties of the syn-



This particular belt is clearly marked with its material type.

thetic rubber to change, and in the case of neoprene, the tensile strength and hardness are reduced, but the elongation increases. Tensile strength is how much pulling force you have to apply before it breaks. Hardness is what you would expect. Elongation refers to how much the material will deform before it breaks. Low tensile strength with high elongation means you would not have to pull very hard to break the material, but it would stretch a lot. This is exactly what you do not want to see in your drive belts, and now you know why you don't want them to come in contact with oil!

Nissan also uses a superior material called EPDM (Ethylene Propylene Diene Monomer) for some belts, found often in cooling system hoses. When exposed to oil contamination, EPDM does not lose tensile strength, but its elongation significantly increases. This is why you may see coolant hoses "balloon out" when oil-soaked.

Drive belts aren't solely composed of synthetic rubber. They also have fibers woven into the backing band. These polyester fibers tend to be a polymer of a different family called thermoplastics. Thermoplastics are affected by heat. In the case of drive belts, woven polyester fibers will contract and shrink when exposed to heat, which is a perfect behavior for keeping tension on a pulley. The fibers are coated with another plastic, PVC (polyvinyl chloride), which allows them to flex without fraying. The fibers gain increased tensile

strength from the significant number of threads wrapped together, as well as their length.

Like tires, you get what you pay for with drive belts. There is a lot of materials technology and engineering involved in making drive belts, and just as with tires, investing in a better quality part is better for everyone involved. Nissan drive belts are the best belts for Nissan vehicles.

Where'd the Drive Belt Go?

In some new hybrid configurations, the drive belt may have gone the way of the Dodo. Using the high-voltage battery pack and multiple computer controllers, the Altima Hybrid eliminates the A/C compressor belt. The belt-driven compressor is replaced by an electrically-driven compressor, which allows for greater efficiency. The 2012 Infiniti M series has eliminated the power steering belt by using an all-electric power steering rack that does not have an external hydraulic pump.

For an engineer, being able to control the load and demand from accessories on the fly dramatically improves fuel economy. They can do this best by turning an "always on" drive belt configuration into an "on demand" electrical system. As with all their technologies, expect Nissan to develop a way to go beyond the typical drive belt. |



SHIFT the way you move

Introducing the Nissan eStore



Ordering OE parts has never been easier. Genuine Nissan OE replacement parts always deliver model-specific engineering, perfect fit and like-new performance. And now, they're just a click away with the all-new Nissan eStore.

- Easy-to-use OE Parts Catalog
- Full VIN Decoding
- Parts Illustrations for Most Nissan Vehicles
- Order Online 24/7
- Fast Delivery from your Local Nissan Dealer

Trust the Original. Genuine Nissan Parts.

parts.NissanUSA.com

Here's How it Works:



Ready.

Enter your vehicle model and year. Select the specific category for the part you need. This is also a great time to identify other possible components you may need to properly complete the job. Choose your specific parts required. Add these parts to your shopping cart.

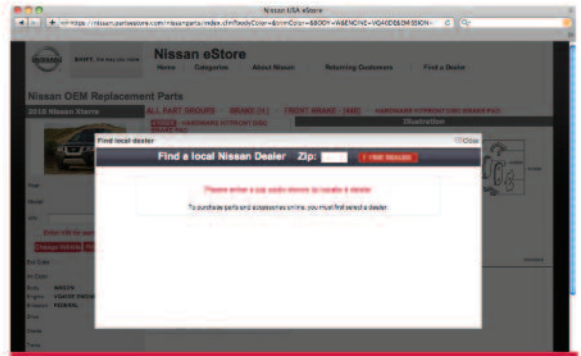

Set

If you are new customer, enter your Zip code to see the closest dealers to you. Choose a dealer, submit your account information, then the dealer will set custom pricing for your shop and e-mail you a confirmation. As a returning customer you'll be able to immediately access your dealer specific webpage and custom pricing.



Click.

Once you're logged in, the chosen part(s) are still in your in box, but now the custom pricing of that dealer is shown. Once added to the shopping cart you can continue to checkout.

Advanced Driver Assistance System (ADAS)

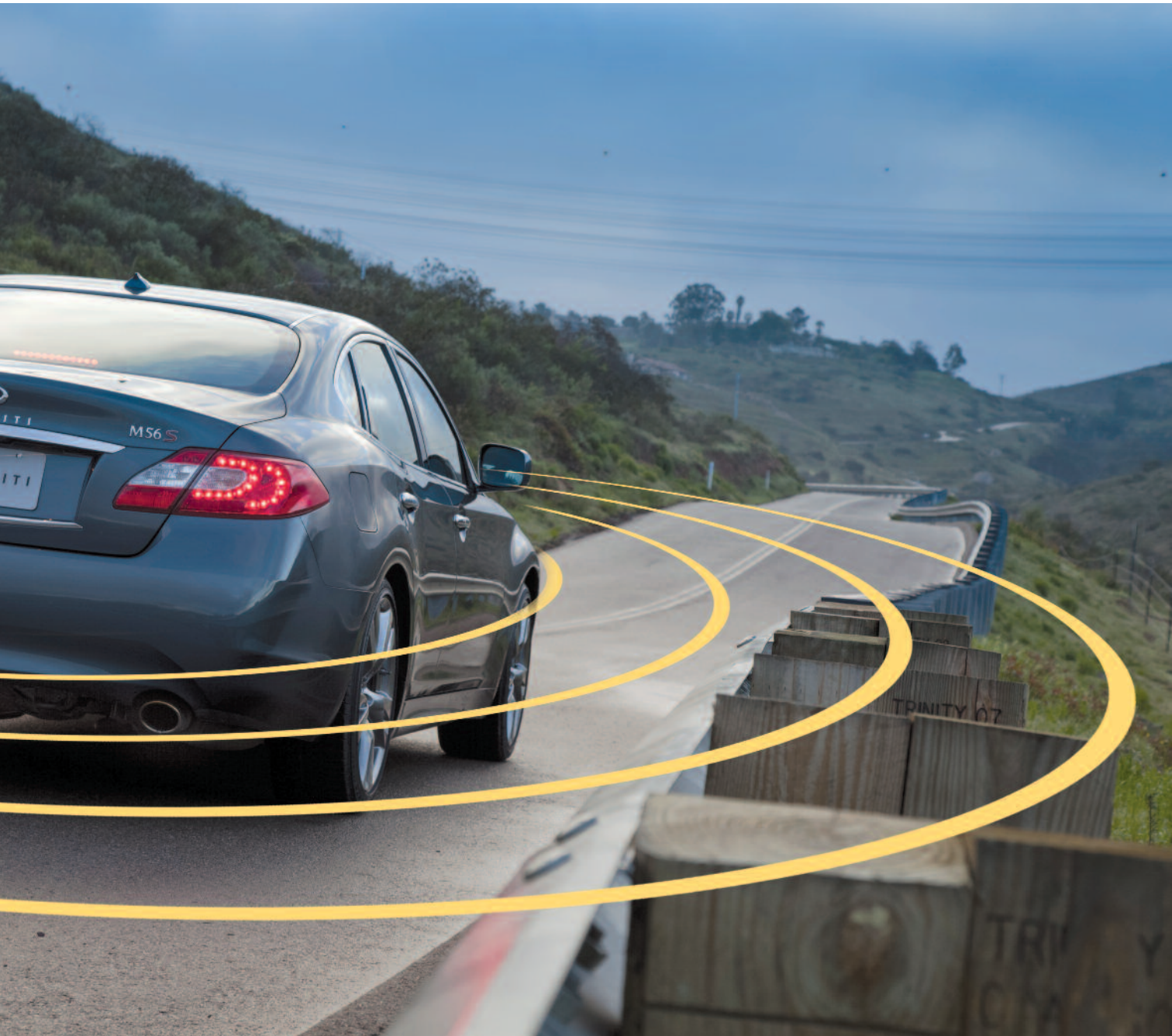

Lane Departure Prevention, Intelligent Cruise Control, and other advanced controls are Nissan's newest line of features in some vehicles.

Accidents happen. Sometimes nothing can be done to avoid a collision, but Nissan goes the extra mile with some of its newest vehicles to help reduce the likelihood of an accident occurring. We'll take a look at how radar, sonar, camera, and laser inputs are used to monitor the area around the vehicle. This information, when combined with on-board VDC (Vehicle Dynamic Control) and all-wheel ABS, creates a car that can alert the driver about potential hazards. In some cases, the car can help reduce the severity of an accident by predicting an imminent collision. Taken together, these are often referred to as "Nissan Safety Shield Concept Technologies."

High-tech help for the motorist

It's important to remain consistent with our terminology, so let's spend a moment to talk about all the vehicle controls that comprise the Advanced Driver Assistance Systems (ADAS). ADAS works with Vehicle Dynamic Control (VDC) to assist the driver by slowing the vehicle as necessary to maintain safe distance, or to use differential braking to create yaw adjustments, effectively steering the car. The core of ADAS is made up of sensors that are able to survey the road combined with VDC and ABS controls that allow the car to adapt to its surroundings.

In order to "see" forward-oriented objects, ADAS uses a forward-sweeping laser that can detect other vehicles, interpret their speed, and logically determine whether to apply the brakes and alert the driver. Two other assistance systems utilize this forward laser: Intelligent Cruise Control (ICC) and Distance Control Assistance (DCA). Both must be toggled and controlled by the driver using a switch. These systems utilize the forward ICC Sensor for decision making. In the case of ICC, the car will automatically adjust the vehicle's speed and distance in relation to another vehicle in front in order to provide comfort when cruising, and to eliminate the need for constant adjustments by the driver. DCA works in a similar fashion, but if it is turned

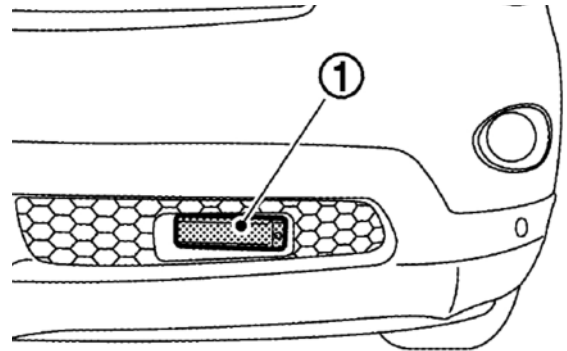

The main ICC sensor (1) also houses the computer used in determining how to control the rest of the vehicle based on sensor input.

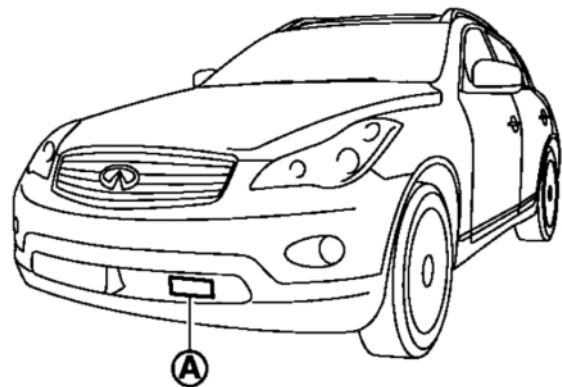

The ICC Reflector Detection Sensor (A) sweeps forward, identifying its surroundings based on other vehicles' standard-issue light reflectors.

on, the vehicle will attempt to assist the driver at all times. This means that when DCA is engaged, the car will actively brake to a stop within the limitations of the system as necessary.

Lane Departure Prevention (LDP) uses a front camera mounted in the windshield to help keep the driver

Nissan & Infiniti Advanced Vehicle Safety Controls

from wandering over the center lines, or onto the shoulder. This assistance feature must be toggled by the driver, and is temporarily disabled when using the turn signal.

Intelligent Brake Assist (IBA) helps the driver in the event of an emergency stop. IBA will remove the brake pedal free play, which shortens the effective reaction time of the driver. However, without any driver input, the vehicle won't do anything on its own.

There are also many audio and visual warning systems that increase the driver's awareness of his surroundings. When DCA detects another car ahead, the gauge cluster display will turn on the vehicle detected icon. If DCA cannot stop the vehicle in time, the Forward Collision Warning (FCW) will alert the driver with a chime that he must apply the brakes. Likewise, if another vehicle is located in a blind spot, the Blind Spot Warning (BSW) lights will be activated, and if the driver puts the turn signal on, a chime will sound. Of course, it's up to the driver to properly signal for turns, and the system will not steer the car for him or her.

Many of these new features also help make ordinary tasks like parking or commuting safer. Multiple cameras make it easier to park or maneuver in tight spaces, and the ICC can allow a driver to retain safe distances while driving on straight highways. Let's take a closer look at each subsystem.

The ICC Sensor makes DCA and Intelligent Cruise possible

There are multiple sensors, radar and sonar-emitting devices on the newest Nissan and Infiniti vehicles equipped with ADAS. Yet, the primary forward-looking sensor is a laser, and it lives below the bumper cover of vehicles so equipped. It also serves as the computer for making decisions about the vehicle's position in time and space. These calculations are shared over CAN communications so ADAS can coordinate with DCA and ICC as necessary. Keep in mind that these advanced sensors are a trim-level option, and are not standard on every car.

Nissan calls the forward sensor cluster the ICC Sensor because it sweeps a laser beam outwards, and makes decisions based on the light that reflects back. The horizontal motion is calibrated internally, or at time of replacement, and if any upcoming threats are identified, the unit itself will communicate with the vehicle's primary ECM and ABS control unit to act accordingly. In many models, all information about detected objects

is calculated within the ICC sensor unit. These distance findings, when plotted over time, give the ICC ECU a sense of how fast the vehicle is moving toward identified objects.

When compared with inputs from the ABS ECU regarding vehicle speed, and from the ECM noting accelerator pedal position, the ADAS makes logical conclusions about whether the vehicle is at risk of collision with any of those perceived reflectors. It's the same way a police officer's laser gun determines speed.

An important note is that the forward ICC sensor is designed to ignore stationary reflectors, such as those found on guard rails or parked vehicles. Therefore, the driver is the most important safety feature on any vehicle, because only he or she can determine whether there is a stationary object on the road ahead, or if the road curves abruptly.

The ICC sensor is able to look just under 400 feet ahead. This long detection range makes DCA and Intelligent Cruise Control possible. Both features allow for the driver to set a desired following distance, and the ADAS can monitor and control the vehicle speed as necessary to maintain that distance. That is, with a little help from its friends, the ECM and the ABS control module. DCA logic works simply when its vehicle approaches another car:

1. If the driver DOES NOT have his or her foot on the accelerator pedal (information provided from the ECM), up to 25% of the vehicle's total braking power will be commanded (carried out by the ABS control unit) to slow the car down.
2. On some models, if the driver DOES have his or her foot on the accelerator, the pedal assembly's actuator will push against the driver's foot in an effort to aid his or her letting off the accelerator.

If the driver forces the accelerator down despite the upward nudging mentioned above, Intelligent Cruise or DCA will be overridden. For as long as the driver is accelerating, the DCA or intelligent cruise will NOT apply braking even though it may "think" that is better. The driver may notice that the brake pedal goes down of its own accord during DCA or intelligent cruise. This is normal operation.

When driver braking input is required to stop, the FCW will sound a chime and blink the vehicle-ahead indicator on the gauge cluster display. If the driver goes against the DCA's attempts, the system will cancel and NOT fight the driver.

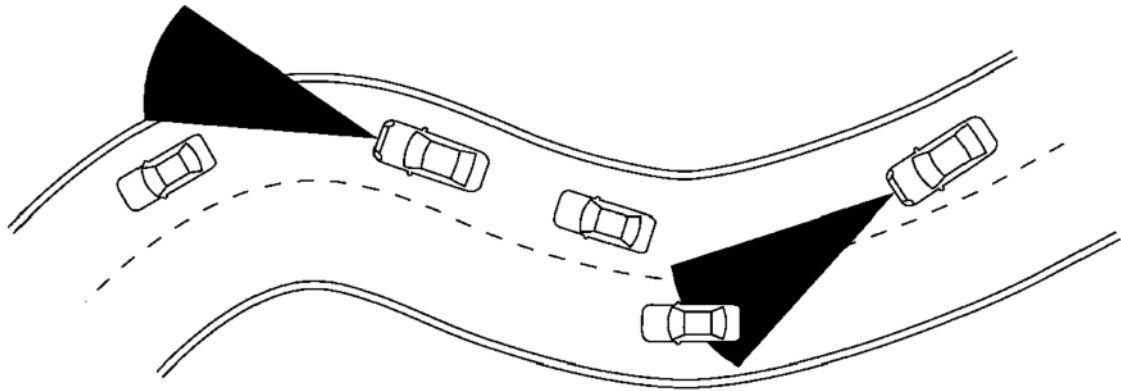

The sweep cone of the ICC Reflector Detection Sensor can be tricked by twisting roads. Safety systems are only a backup for the driver, who is responsible for paying attention at all times.

Vehicular Peripheral Vision

Human drivers don't just stare straight ahead without regard for what's around them. We must constantly monitor our surroundings to make safe lane changes, or react to possible threats. Some newer Nissan vehi-

cles have advanced assistance features also include side radar devices to detect other cars in your blind spots and report on the danger using Blind Spot Warning (BSW) indicators. The BSW system has its limitations, however. For example, like the forward ICC sensor, side radar cannot detect stationary objects. Also, it may not observe another vehicle merging at a far lane into the blind spot during a lane change. Lastly, the BSW will not "check" for a vehicle unless you use your turn signals. The turn signal switch is the first step in activating BSW, and only good driving habits will ensure the driver is signaling. Most importantly, BSW does not take the place of checking with your own eyes.

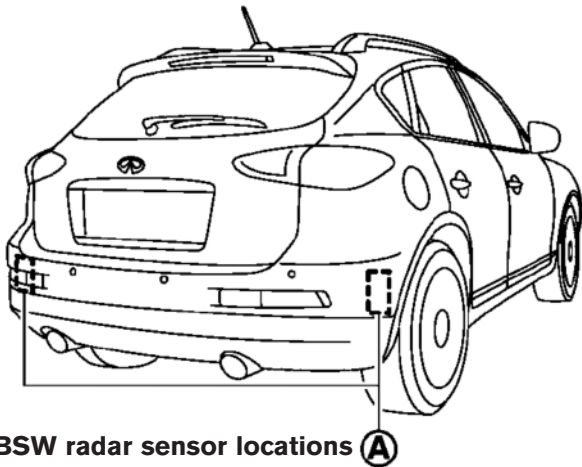

cles' advanced assistance features also include side radar devices to detect other cars in your blind spots and report on the danger using Blind Spot Warning (BSW) indicators. The BSW system has its limitations, however. For example, like the forward ICC sensor, side radar cannot detect stationary objects. Also, it may not observe another vehicle merging at a far lane into the blind spot during a lane change. Lastly, the BSW will not "check" for a vehicle unless you use your turn signals. The turn signal switch is the first step in activating BSW, and only good driving habits will ensure the driver is signaling. Most importantly, BSW does not take the place of checking with your own eyes.

Bumper stickers may obscure the sensors and

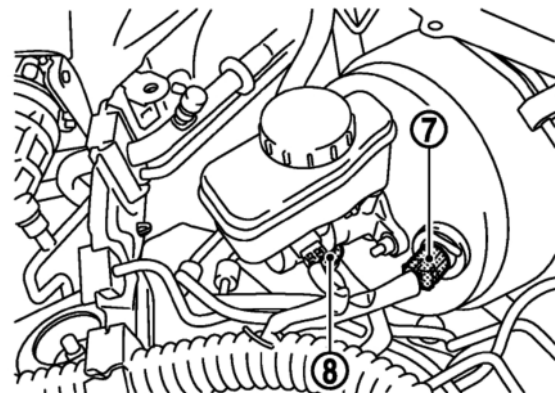

The boost solenoid (7) is responsible for firming up the pedal in event of emergency. The brake pressure sensor (8) is used in calculations for ABS/VSC behavior.

The "Voice" of an Intelligent Car

When the forward ICC sensor cluster determines that driver input is necessary to prevent a problem, there will be a warning chime and a gauge cluster indicator. This is also considered the Forward Collision Warning (FCW).

When a customer signals for a turn, the ADAS will check the right- or left-hand radar sensor about whether the blind spots are clear. If an object is detected, the blind spot indicator (BSI) located on the door

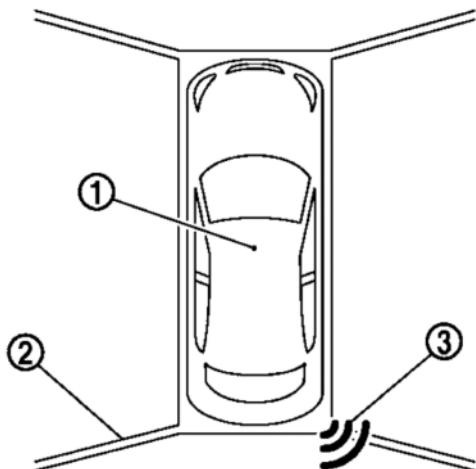

The bird's eye view camera shows the car (1), the wide angle rear camera view (2), and a sonar proximity warning indicator (3).

mirror corner cover will illuminate orange to alert the driver that something is there. Likewise, the dash indicator will illuminate. If the turn is continued, a warning chime will sound and the BSW dash indicator will blink. At that point, the driver may or may not stop the collision course, but the car has done all in its power to reduce the chances of mishap.

NOTE: Radar may not accurately detect small objects like bicycles or motorcycles.

Intelligent Brake Assist takes up the slack

Nissan has designed its new assistance systems well enough that a car equipped with ADAS features will often “know” that it will be in an accident before the driver does. The “preview function” will activate when the ADAS has determined that a forward collision is inevitable. In times of these detected emergencies, the ADAS communicates with the ABS control unit to provide a small amount of pressure to the booster, which eliminates the free play in the brake pedal. This happens before the driver even knows there's an emergency, and once he or she does, the brake pedal will be firm and immediately begin working.

If there is no emergency, after one full second, the pre-loaded brake pedal will return to normal. Likewise, if the driver pushes the brake or accelerator pedals, IBA will cease.

Vehicle Dynamic Control and ABS

While the ICC systems are indispensable for figuring out what to avoid, Vehicle Dynamic Control (VDC) is responsible for ultimately making it all happen. VDC works in conjunction with ABS, interpreting signals from the ADAS computer and the primary ECU. VDC will control brake pressure to reduce wheel slip, so power is transferred to a non-slipping axle. It also controls engine output directly via the ECU and fuel injection cut off. It monitors brake pressure and accelerator pedal pressure to determine the reaction and intention of the driver. VDC is also the primary factor in making Lane Drift Prevention (LDP) possible.

The LDP uses a camera positioned near the rear-view mirror to interpret lane markings. If a road does not use lane markings, or the ones visible to the driver are worn, LDP will not work properly. It will also not make lane corrections greater than 20 degrees, so don't expect the car to steer for you. Also, LDP is only active at 45 mph or greater.

Lane Departure Correction begins when the ADAS notices that the driver steering input indicated by the steering angle sensor is not sufficient to continue the trajectory between the visible lane markings. Once this is detected, the system does NOT move the steering wheel. It begins to apply braking pressure by means of VDC to one side of the vehicle. In other words, if LDP wants to steer the vehicle slightly to the right, it will apply light brake pressure to the right front and right rear. VDC will receive the data from the ADAS, and then, in turn, command the ABS to apply brake pressure to the necessary wheels.

In the meantime, the LDP warning indicator will illuminate on the dash and a chime will attempt to wake up the driver, or otherwise alert him or her of the car's corrective action. If the driver was attempting to change lanes as indicated by the turn signal, LDP will not fight with the driver and once he or she continues to steer consistently in a particular direction, LDP will automatically cancel. As expected, if the driver uses the turn signal, LDP will temporarily be disabled in the direction of the signal.

Because LDP uses a forward-facing camera, driving directly into the sun can prevent normal operation. This is also true of the ICC sensor cluster's laser. It can also fail due to low light or adverse weather conditions. Using common sense, it would probably be best to control your car yourself in those situations anyway.

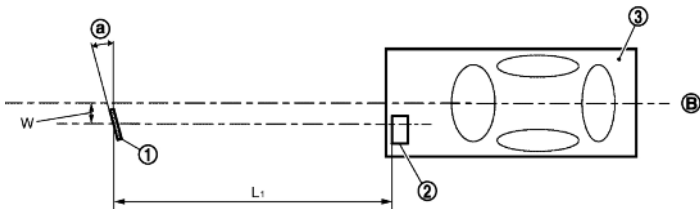

The special service tool reflection plate (1) must be placed about 13 feet (L1) from the ICC sensor (2). The center of the vehicle (3) will be about 10 inches (W) off-set from the reflection plate, which is set at a 25 degree angle (A).

Parking Assistance/Around View Monitor

Not only do modern Nissan and Infiniti vehicles enhance driving safely, they come equipped to handle the most common parking situations. Many low-speed accidents can occur, and multiple cameras can help drivers notice their surroundings better. There are usually three cameras and a set of sonar devices that will display the vehicle's surroundings when reverse is engaged. On the primary Multi-Function Display (MFD), once the car is shifted into reverse, the driver will get a rear camera view with two perspective lines. The two lines represent the width of the vehicle, and the tick marks represent approximate distance. The standard reverse camera is common enough, but once the driver toggles a button on the MFD, he or she can gain access to a wide-angle rear-view camera, a passenger side view, a bird's-eye view, and a front camera if necessary.

The side camera is located on the passenger-side mirror. The bird's eye view is actually quite interesting because it generates a composite from the input of all the cameras to create a facsimile of where your vehicle is in space. The front camera gives the same ability as the rear camera to "get right up" to something, which is excellent for parallel parking.

Service and Diagnosis of ICC

Considering the newness of these technologies, there is no precedent for what may malfunction as a matter of course. All cars break, but some cars will be involved in a collision despite their modern features. Many auto body shops will likely have to replace the ICC sensor module in the front bumper. Such service should be performed by a facility competent in Nissan repair. First, the CONSULT III plus is required for the calibration of the sensor once it's been installed. There is no way around this. Second, a special service tool (J-45718) is required to set up and calibrate the ICC laser.

We cannot stress enough that it is important to look up the specific step-by-step procedure for the vehicle concerned at <http://www.nissan-techinfo.com>. Just to give you a basic idea of what's typically involved, however, we'll say that once the tools are set up, you should ensure that there is nothing behind the reflection plate that may interfere with calibration. Begin work support functionality on the CONSULT III plus, choose LASER BEAM ADJUST and begin to calibrate the vertical orientation of the laser. This requires turning the adjusting screw on the ICC sensor assembly, and once it is within vertical spec, pushing END on the CONSULT III plus. It will take about 10 seconds for the CONSULT III plus to automatically configure the horizontal scan. Confirm the repair with a test drive using DCA.

An important diagnostic tool is also the memory stored of the last reason for cancellation of cruise control. Many of the first difficulties with the system will likely be customer complaints that ICC "stopped working" for some reason. Using the CONSULT III plus, choose work support and you can identify the last five CAUSE OF AUTO-CANCEL. For example, operating the windshield wipers on high will cancel the auto-fol-low feature of ICC, but it will not cancel conventional cruise control. This may confuse your customers, but from the car's perspective, if you have to use your wipers, the reliance on a possibly obstructed laser may be a hazard. Likewise, when ABS is engaged, it cancels DCA as well as ICC, but not the conventional cruise control.

We'll close with a few extra notes:

- ADAS functions vary greatly by model and year.
- The newest JX model will use radar for the ICC sensor.
- The JX also has new functions that we will cover in a future article.
- Newer models have customizable settings for enable/disable. |

Body Basics Premier Products

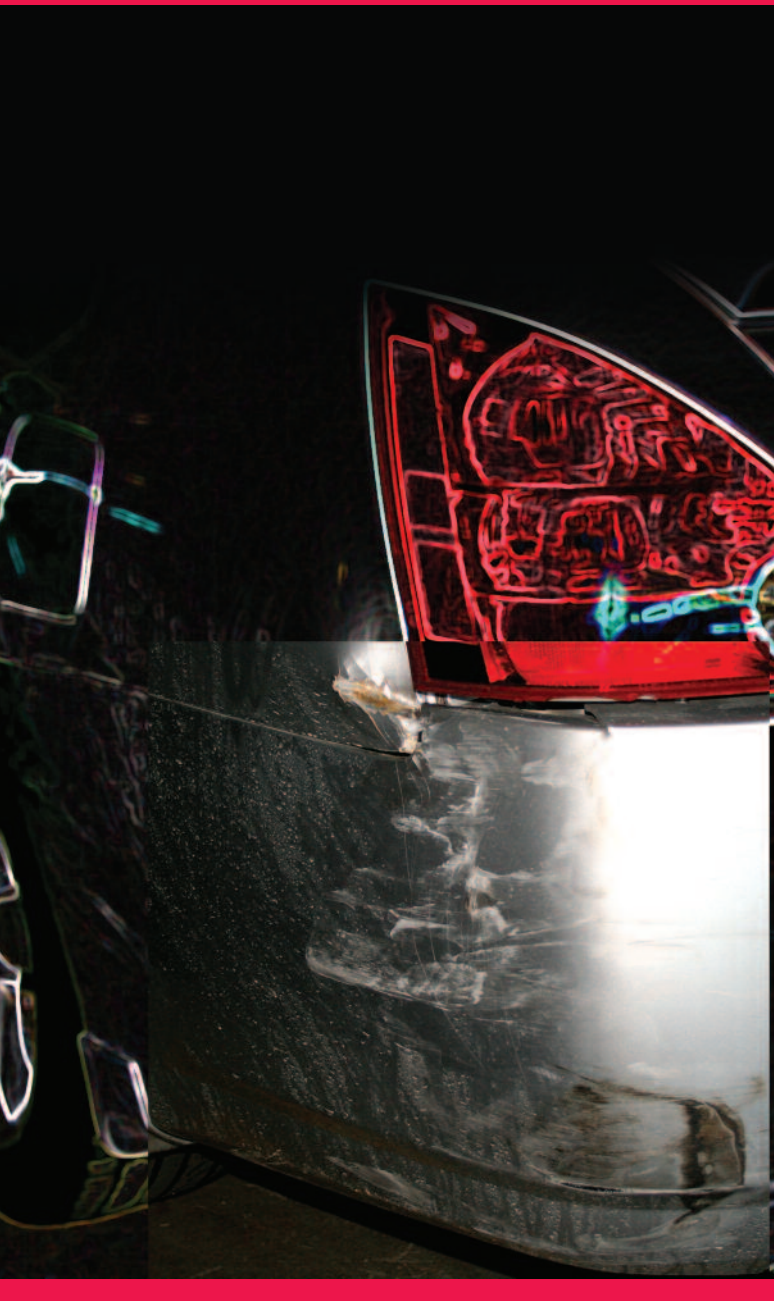

Who knows better which body finishing tools and products work best than the manufacturer of the vehicle? Nissan thoroughly researches and tests the products used in the manufacture of its Nissan and Infiniti vehicles. The same scrutiny goes into deciding what tools and products should be used in Nissan and Infiniti dealers for repairing and servicing vehicles. These same tools and products are available to independent aftermarket body service and collision facilities.

It makes sense to use these Nissan-approved tools and products to return the vehicle to its factory-new condition. The vehicle will not only look and perform the way it was designed, but the customer will be satisfied that the vehicle still maintains its original beauty and integrity.

Body Alignment Equipment

The best end results begin with properly straightening and aligning the body. The body is the structure that holds the rest of the vehicle together. If it's not properly straightened, the components attached to it will not be correctly aligned. To achieve the best results, a high-quality, full-function body straightening and alignment system must be used. Nissan has thoroughly tested the best alignment systems available on the market today and mandates them for Nissan and Infiniti dealerships. These same systems are also available to independent aftermarket collision facilities. Nissan recommends the use of a modern three-dimensional electronic measuring, and/or fixture system with an anchoring and straightening rack or bench to allow 360° pulling. Additionally, of course, the use of Nissan body dimension data for damage analysis and repair is the very best way to go.

In this installment, we'll look at the benefits of using Nissan-approved body alignment equipment and associated tools, bonding and mating products, surface prep, paint and finish products and tools.

Frame Racks

Among the Nissan-approved frame racks are:

- The BenchRack Series, the Mark 6 Series Bench Systems and the SPEED Plus Frame & Lift from the CAR-O-LINER Company.

The BenchRack Series offers several models and optional component packages to tailor the system to your own needs.

The Mark 6 Bench System is a movable system with an incorporated lift and improved lifting capacity.

The SPEED Plus Frame & Lift is ideal for light duty sheet metal pulling and pulls from both ends to keep your full-size alignment bench free for structural repair.

- The EZ Liner Express Portable Structural Repair System and the Impulse System from Chief Automotive Technologies.

The EZ Liner features five tons of power in a smaller, high-quality collision pulling system.

The Impulse System offers power and performance, versatility and options in one affordable package.

- The Power-Pro Series Collision Repair Rack from Blackhawk.

The Power-Pro SL series of racks feature an extended-height lifting capability for ergonomic working heights, an open front and rear for greater accessibility to the vehicle for repairs, a faster pinch-weld anchoring system with fewer bolts to secure it to the rack platform and 60% more chain tie-downs for efficient vehicle tie backs.

Each of these alignment systems has unique qualities and offers a range of purpose, sophistication, accessories and value. All are available through the Nissan Tech-Mate website at www.nissantechmate.com.



The SPEED Plus Frame & Lift from the CAR-O-LINER Company.



The Impulse System from Chief Automotive Technologies

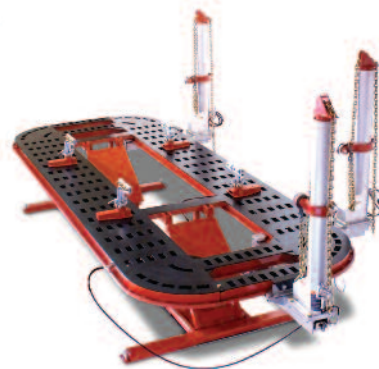

The Power-Pro series repair rack from Blackhawk.

Nissan & Infiniti Body Basics

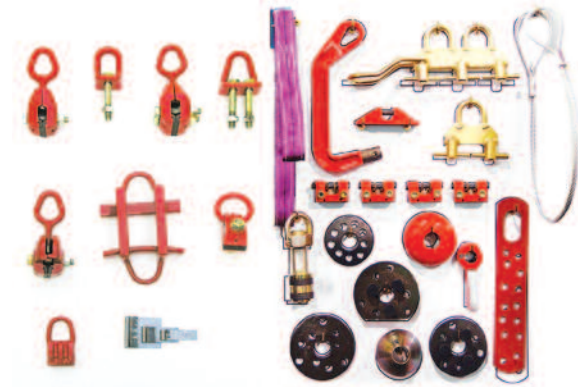

A good assortment of accessory pulling tools and devices helps make the work go quicker and easier.



Use accessory pulling tools to save time and get the proper measurements.



The Velocity measuring system from Chief Automotive Technologies.

Using accessory pulling tools and devices makes the work go quicker, smoother and more completely, resulting in the best alignment and body straightness. The components will fit better and the finished repair will look more professional. When selecting a rack system, make sure you can procure and use a variety of add-on tools for optimal results and quicker labor time for the highest profit margin and customer satisfaction.

Computer Measuring Systems

Using a computerized measuring system is the quickest, most accurate way to perform body straightening and alignment. Many good systems are on the market. Nissan offers the Velocity system from Chief Automotive Technologies through the Nissan Tech-Mate website at www.nissantechmate.com.

The Velocity system is highly sophisticated, yet simple to learn and operate. It features a fast and easy set-up with full-color one-page reports on the exact condition of the vehicle's frame before, during and after repairs have been made indisputable evidence of damage severity and quality repairs.

Bonding and Mating Products

The importance of using the correct bonding and mating products for each procedure cannot be overemphasized. One "glue" does not work for all applications. Various adhesives are required for different applications. The best adhesive for metals, plastics or composites to components of the same or different type will ensure a strong bond while offering flexibility where needed. Be sure to research the best choice before making a mistake that could jeopardize the entire repair.

Nissan has approved 3M bonding and mating materials for use on the company's vehicles. Other companies may offer bonding and mating products that may also meet Nissan approval.

Surface Prep

Surface prep is a critical step in producing a smooth, durable and handsome repair. No amount of paint and polish is going to hide a poorly prepped surface. Always use the proper body fillers, surface prep, buffing and polishing products that meet the manufacturer's specifications.

Nissan approves 3M surface prep tools and products. Other companies may offer surface prep tools and products that also meet Nissan approval.

Paint & Finish Products

If the paint and finish process isn't correct, it may not matter how strong the repair is or whether or not the body alignment is accurate. The first thing the customer – and anyone else who looks at the vehicle – is going to see is the finish. Always use the best and correct products in the finish process.

Nissan has approved several manufacturers for refinishing materials, including the Dupont family of products:

- Dupont
- Spies Hecker
- Standox

There may be other companies who offer paint finish products that meet Nissan's specifications. Please contact your local Nissan and Infiniti dealer to procure these products or further information.

As pointed out in the "All About Waterborne Paint" article in the March 2011 issue of Nissan & Infiniti Tech News, waterborne paint is the new industry standard. The Environmental Protection Agency (EPA) mandated by federal law that all facilities should comply by switching over to waterborne paint and application equipment earlier this year. Please see that article for more information.



Preparing the surface properly will give the best results.



Dupont paints and finish products are approved for use on Nissan and Infiniti vehicles.

Resources

The best source for obtaining many of these Nissan-approved products is the Nissan Tech-mate website at www.nissantechmate.com. The Tech-Mate website can also be accessed through the Nissan and Infiniti Technical Information websites at www.nissan-techinfo.com and www.infiniti-techinfo.com, without having to purchase a subscription or logging on.

Using the Nissan and Infiniti technical information websites ensures getting the proper information to get the job done right, the first time and quickly.

Here's a list of Nissan-approved suppliers. Many more companies also offer excellent products for body and collision service:

Aligning Systems

Blackhawk Equipment
www.blackhawkequipment.com
CAR-O-LINER Company
www.car-o-liner.com
Chief Automotive Technologies Inc.
www.chiefautomotive.com

Paint & Finish Products

Dupont
<http://pc.dupont.com>

Bonding & Mating Products and Surface Prep Products
3M
<http://3mcollision.com> |

The Basics of Nissan's VVEL System

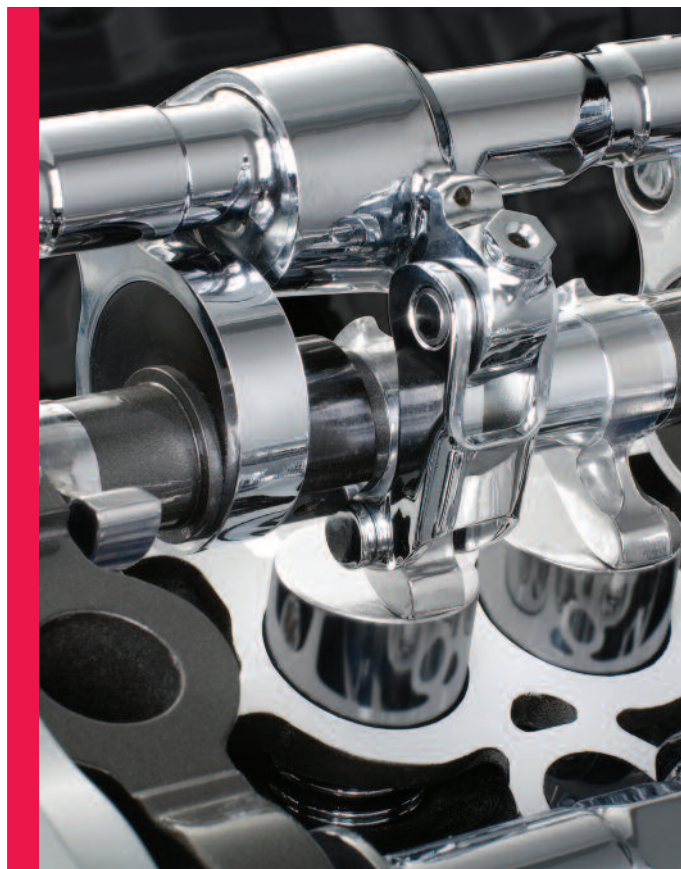

Here's an overview of Nissan's Variable Valve Event and Lift system. We'll look at which Nissan and Infiniti vehicles are equipped with VVEL, how the system functions, and maintenance considerations.

Variable Valve Event and Lift (VVEL) is a system that allows the driver to control engine air intake by manipulating the accelerator pedal, much like the throttle valve does on typical cars. The amount of intake valve opening (valve lift) can be varied from a tiny crack at idle, to maximum lift at wide open throttle. Because the air flow is being controlled by the valve lift, the throttle can be held open to virtually eliminate intake manifold vacuum, thereby increasing efficiency. VVEL is not just another acronym for a valve timing system; it's a major shift in the role of the intake valves and a leap forward in internal combustion engine efficiency, response, and power.

Controlling air flow directly at the combustion chamber has always been optimal, but because of technology, cost, and reliability hurdles, it hasn't been practical until now. We'll examine the benefits and operation of VVEL in the hope it will provide an appreciation and understanding of the system, so readers will have a leg up when they first encounter a diagnostic challenge on a VVEL-equipped engine.

Which Vehicles Have VVEL?

The following vehicle and engine combinations are equipped with VVEL systems:

2008 Infiniti G37 Coupe: V6 VQ37VHR

2009 Infiniti G37 Sedan: V6 VQ37VHR

2009 Nissan 370Z: V6 VQ37VHR

2009 Infiniti FX50: V8 VK50VE

2011 & 2012 Infiniti M37: V6 VQ37VHR

2011 & 2012 Infiniti M56: V8 VK56VD

2011 & 2012 Infiniti QX56: V8 VK56VD

You may notice these are all very nice cars. As usual, new technology is installed on the flagship vehicles first, for people willing to pay for the very best available. As production costs come down and efficiency requirements increase, you'll likely see this type of technology trickle down to some of the less expensive models.

Benefits of VVEL

The chief benefit of controlling engine air intake at the combustion chamber is the increase in efficiency due to the decrease in throttling losses. These are losses in engine efficiency due to the energy used to create intake manifold vacuum. In other words, creating intake vacuum is work and as such, burns fuel. If fuel is used to create a vacuum, it cannot be used to move the vehicle down the road, thus fuel is wasted on a function that does not aid engine output.

Have you ever blocked the hose on a household vacuum cleaner with your hand? Does the motor sound like it's working harder when the hose is blocked? It sure does! You may even notice the lights dim because of the extra load. The throttle plate restricts the intake flow just like a hand covering a vacuum cleaner hose. This makes the engine work harder, especially at idle, when the engine is doing no useable work at all. However, this is necessary on a conventional throttle engine, because without the throttle restriction, the engine would race uncontrollably. On a VVEL engine, the throttle is opened to reduce manifold vacuum at idle. The engine does not race because the air flow is being regulated with the intake valve lift. The engine is no longer being strangled to regulate rpm; it's operating at its own pace and breathing from an abundance of air at atmospheric pressure.

This brings us to cylinder filling. Superchargers and turbochargers increase the pressure in the intake manifold to help force more air into the cylinder. They increase air consumption beyond the engine's natural volumetric efficiency. So, what do you suppose happens when the intake manifold is at atmospheric pressure instead of a vacuum? Let's see.

On a conventional throttle engine, air will not start to flow into a cylinder until suction generated by the cylinder during the intake stroke exceeds the vacuum in the manifold. If the intake manifold vacuum is 21 in.Hg, the cylinder must generate over 21 in.Hg before it starts to fill. So, if there is no vacuum stored in the manifold, but instead atmospheric pressure, air will be "pushed" into the cylinder sooner in the intake stroke, resulting in more air entering the cylinder, and thus, better cylinder filling.

In addition, the velocity of the air entering the combustion chamber is higher, which results in better fuel atomization and a reduction in partial combustion. When fuel is burned completely, it increases fuel effi-

ciency and decreases hydrocarbon emissions.

Improved throttle response is another benefit of VVEL. When the throttle plate is suddenly opened on a conventional throttle engine, it takes time for the intake manifold to fill with air, and for the vacuum to become equal to atmospheric pressure. This delay results in a lag time between when the accelerator pedal is pressed and when the engine output reaches the desired level. On the other hand, the response on a VVEL engine is near-instant. The power output matches the accelerator input in virtually real-time.

Finally, maximum valve lift can be increased without negatively affecting idle quality. On a conventional throttle engine, valve lift must be balanced between what is optimal for idle and what is optimal for maximum load. Creating a cam profile that has a lot of lift will also increase the duration; the ramps up and the ramps down can only be made so steep. At idle, excessive lift will cause poor air velocity and fuel atomization, and excessive duration will cause blowback into the intake manifold. If a camshaft is created for maximum power, idle quality will suffer. If a cam is created for the best idle quality, maximum output will suffer. With VVEL, the best of both profiles can be used without sacrificing anything, a silky smooth idle and up to over 400 horsepower!

As you may have gathered, the benefits of VVEL are most noticeable at low and medium loads, when the throttle plate would be more closed than open. Therefore, VVEL is most effective on vehicles with high output engines that are more likely to be operated at relatively low to medium loads.

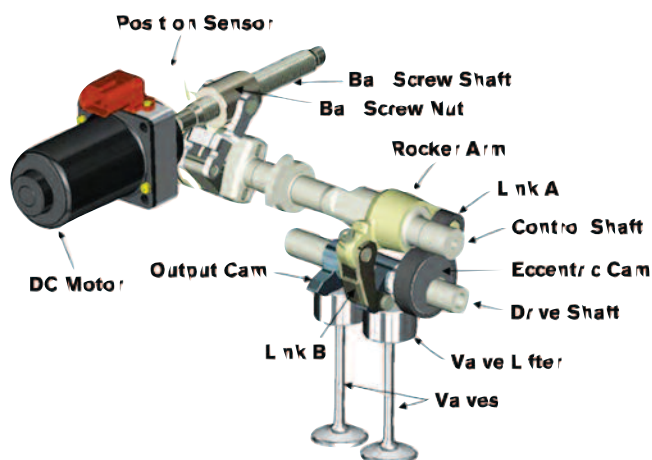

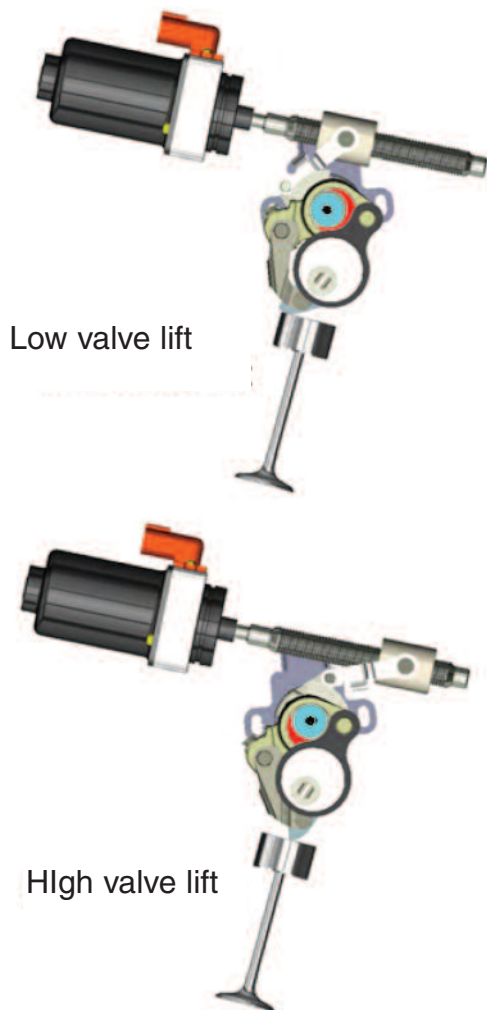

Note the position of the control shaft, colored light blue and red. As the control shaft rotates, the fulcrum is moved and valve lift is modified.

How VVEL Works

The exhaust cam is a traditional design. Its egg-shaped lobes push on solid lifters mounted atop the exhaust valves. The VQ37VHR engine does not incorporate variable exhaust valve timing. The VK56VD and VK50VE engines use hydraulically actuated duty-cycle-

controlled camshaft sprockets to adjust exhaust cam timing to match engine operating conditions, similar to the continuously variable valve timing system found in many previous engine packages. In short, the exhaust valve system on a VVEL engine is the same as on a conventional throttle engine.

The intake side is wildly different. The intake cam is replaced by a drive shaft with eccentric cams where the lobes would normally be. It does not have conventional egg-shaped lobes; it's more like a small circle offset within a large circle. The drive shaft is mounted to an electro-hydraulically adjustable cam sprocket, so intake valve timing is continuously variable. The eccentric cam does not ride on the lifters directly. Its movement is transmitted through a link, to a rocker arm, to another link, and then to an output cam, which presses directly on the lifter. The fulcrum of the rocker arms is a control shaft, which is connected to a DC stepper motor called the VVEL actuator. When the VVEL actuator rotates the control shaft, the rocker fulcrum is shifted due to an eccentric mount, and the valve lift is changed.

Think of a seesaw. If the fulcrum (pivot) is in the center, the amount of movement on each side will be equal. If the fulcrum is moved to the left of center, a smaller amount of travel on the left will cause the movement on the right will be increased. If the fulcrum is moved to the right of center, the opposite will be true. This is how valve lift is controlled with the VVEL system.

The ECM looks at the crankshaft position sensor to determine engine speed and piston position, and the accelerator pedal position sensor to determine desired power output. The ECM then continuously adjusts the control shaft position via a VVEL control module while receiving feedback from a position sensor mounted on the VVEL actuator assembly.

Service Considerations

As a service technician, valve adjustment may be the first concern that comes to mind when considering VVEL. These engines all have solid lifters and therefore, there is no self-adjusting mechanism. However, special coatings, years of metallurgical development, and top quality engineering have resulted in valve trains that are very durable, and can go hundreds of thousands of miles without needing adjustment. That being said, valve clearance should be checked "whenever you're in the neighborhood." If the valve covers are removed for any reason, or there is unusual noise or engine roughness, valve clearance should be inspected.

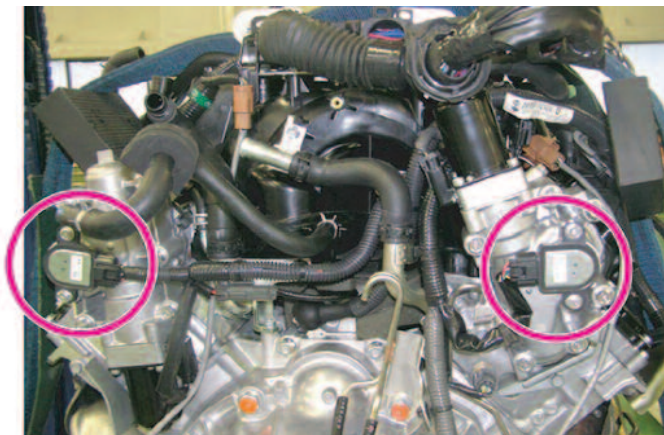

Replacement VVEL control shaft position sensors require a one-time adjustment when new. The sensors are not variable resistance potentiometers like a TPS. They are resolvers. A permanent magnet is mounted to the end of the control shaft, when the shaft rotates changes in the magnetic field cause sensor output voltage to vary with shaft position. The output signal is interpreted by the VVEL control module, and then sent to the ECM.

Both intake and exhaust valve clearance should be measured, but only exhaust valve clearance can be adjusted. If any of the intake valves are out of specification, the cylinder head and VVEL ladder must be replaced as an assembly. If the exhaust valves are out of specification, selective thickness lifters are available to provide up to .020 in. of correction in .0008 in. increments. The exhaust valves, valve seats, guides, and stem seals can all be replaced if need be, provided your shop has the necessary machine equipment, but no individual parts are available for the intake side.

If the VVEL actuator is replaced, an initial adjustment must be performed. The VVEL system must be prepared for adjustment using the CONSULT. Under WORK SUPPORT, select VVEL POS SEN ADJ PREP. Once complete, adjust the VVEL actuator position sensor so that its PID reads 500mV +/- 48mV. This procedure should ONLY be performed when the actuator is replaced, and ONLY on the side that was replaced. Make sure not to get confused and mess with the adjustment on the wrong bank. If you do, you'll need to replace the VVEL actuator.

Correct Lubrication

Service requirements are pretty typical for VVEL-equipped cars. Motor oil requirements are SM/GF4 or SN/GF5 depending on model, with no requirement for full synthetic or a proprietary certification. The service interval should be 3,750 miles for most drivers, and 7,500 miles for the atypical all-clear-freeway type driver. However, it would be wise to consider the most common cause of failure in variable valve timing systems: oil level and oil quality. Nissan Ester Oil (P/N 999MP-5W30EP) is far less likely to become sludge than conventional oils. It's also far superior to most "synthetic" motor oils. It's certainly not the cheapest motor oil, but then again, we're talking about some pretty high-end vehicles here, which, if poorly maintained, will retaliate with very high repair costs. If you take care of your VVEL equipped vehicle, it will take care of you.

Sources of Additional VVEL Information

For more detailed VVEL information, use the following resources, which are free with a Techinfo subscription:

- Introduction to Engine Mechanical Systems, Variable Valve Timing Module. This document can be found in the E-Learning Modules section of nissan-techinfo.com.
- 2008 Infiniti G37 Coupe New Model Introduction. This document can be found in the E-Learning Modules section of infiniti-technifo.com.
- Service manuals for G37, 370Z, FX, and QX56

These resources are available for purchase on nissan-techinfo.com and/or infiniti-techinfo.com:

- Video (DVD) Training, Volume 145: Variable Valve Event and Lift System (\$24.95)
- Classroom training materials (PDF booklets), 2009 Infiniti FX New Technology (\$74.95)
- Classroom training materials (PDF booklets), 2011 Infiniti QX56 New Technology (\$74.95)
- Classroom training materials (PDF booklets), Engine Mechanical Service Course EMTC9915A (\$74.95) |



Wheel Bearing Diagnosis and Service

Here are the basics of wheel bearing diagnosis and service, as well as some old-time wisdom and techniques that used to be a little more commonplace prior to the information age. We'll focus on the fixed-preload cartridge style wheel bearings that are most common in modern vehicles.



Perform road testing only in an area where the traffic conditions allow for it.

These days, a lot of emphasis is placed on teaching the electronic and engine management skills associated with automotive diagnosis and repair because they are the most rapidly changing and complex aspects of our industry. However, this does not make mastery of “basic” skills such as wheel bearing diagnosis and repair any less important. Which do you suppose would cause your customer more concern, a MIL/Check Engine Light on, or a wheel falling off? Wheel bearing service, while relegated to “B” skill level in the labor guide, requires skill and knowledge to be performed properly. This skill set can be easily missed in automotive school and in continuing education, and is often taught on-the-job by a co-worker, which can be good or bad, depending on the teacher.

Finding Bad Wheel Bearings

Wheel bearing failures fall within one of two categories: noise/roughness or excessive play. Either way, your customer may not notice anything until the problem has developed into an unacceptable safety issue. Wheel bearing noise may go unnoticed by a driver

because the level increases gradually. The noise may be very subtle, similar to the noise caused by rough road surfaces at first and the driver may not notice that the noise continues on smooth roads as well. With every mile driven, the noise gets a little worse, but the day-to-day increase is so slight, it does not register with the driver. Therefore, it is important to road test cars when they are in for service. A wheel bearing will make a droning noise while moving; in the beginning stages it may only be audible at 35 MPH or greater.

Wheel bearings are not the only possible sources of droning noises. Irregular tire wear, aggressive tread patterns, axle shaft support bearings, and output shaft or differential carrier bearings can all make noises similar to a bad wheel bearing. So how can these other sources be eliminated as the cause?

Road Test Procedures

A road test is critical because it is the only way to test the wheel bearing and drivetrain under strain. A series of maneuvers and observations will help isolate



It doesn't take long to check for play once the car is on a rack.

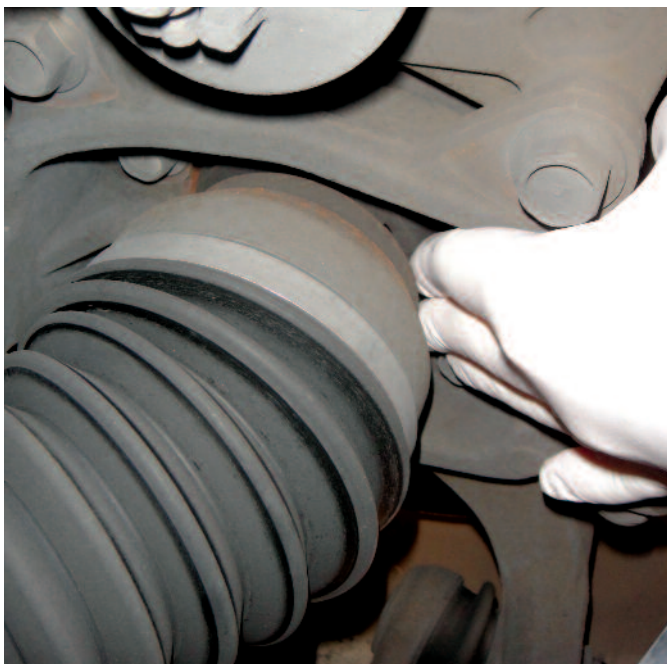

If you find play in the wheel, have an assistant rock the wheel while you determine if the wheel bearing is the source of the movement. Ball joints, bushings, and loose suspension bolts can also cause play.

the cause of the noise. First, accelerate and decelerate slightly while the noise is occurring. Usually, transaxle or differential problems will be affected more by acceleration or deceleration than will wheel bearings. So, if the pitch and amplitude of the noise change substantially with drive train load, suspect the transaxle. Next, swerve the car side to side, if the noise changes with side load, it usually indicates a wheel bearing is the source of the noise. If a variety of road surfaces are easily accessible, take note of how the noise responds to rough and smooth roads. Wheel bearing noise will not be affected by road condition, but tire noise will. Finally, take note of where the noise sounds like it's coming from: front, rear, left, or right.

Rack Inspection

Once back at the shop, rack the car and check the tires for irregular wear and proper pressure. A scalloped or feathered tread pattern can make a noise very similar to a worn wheel bearing. Also, some ultra-aggressive tread patterns will make noise, even when the tread is in good condition. If the tires are suspect, and the location of the noise seemed obvious during the road test, rotation followed by another road test may be helpful. If not, substituting wheels from an identical but noiseless car can be helpful (but not always possible).

If the tires look okay, check for play in each of the wheel bearings by grabbing the tire at 12:00 and 6:00 o'clock, then attempting to rock it by alternately pushing with one hand and pulling with another. If the wheel has play, have an assistant continue to rock the wheel while you verify the movement can be felt by touching the outer CV joint and the knuckle, or the rotor and the knuckle. If movement is found, use a dial indicator and service manual to verify whether or not it is out of specification (usually, only a couple thousandths of an inch is allowed at the hub).

Now, the tricky part: All wheel bearings with excessive play are bad, but not all bad wheel bearings will have excessive play. In fact, you'll find a great number of wheel bearings that make terrible noises, but do not have any play at all... yet! Noise is caused by pitting on the races or the balls/rollers, but unless the pitting is prolific enough, the un-pitted areas of the bearings may be able to maintain proper preload, and there will be no play as a result. However, a noisy bearing with no play is not "good to go." Roughness in wheel bearings will



Springs do a pretty good job of amplifying vibration enough to be felt. When in doubt, compare side to side.

cause extra friction and heat. Once a bearing has started to make noise, it can fail very rapidly, especially if it's worked for a long time without a break, which might occur during a long freeway drive.

When a car is on a rack, the wheels are unloaded, and a normally noisy wheel bearing may fall silent. One technique that is quite useful is to spin the wheel while holding the spring. Vibrations from the wheel bearings are amplified by the spring and can be felt even though they cannot be heard. This works especially well on the non-drive wheels because they spin more freely due to the reduced rotating mass. "Driving" the car on the rack and using a stethoscope to listen for noise at the knuckle will work for some cars. However, most modern cars are equipped with ABS and VSC, so trouble codes will almost certainly set during this type of testing. Also, extreme care should be used when working around moving parts.

What If the Source isn't Obvious?

If road testing and rack inspection do not reveal the source of the noise, a Chassis Ear can be used to listen to the car while the driving on the road. With a

microphone clipped to each knuckle, you'll be able to listen while the wheel bearings are loaded to find the noisy one. The only downside is the setup time and the inevitable wear and tear on the Chassis Ear (microphone clips sometimes fall off, and do not survive being dragged along the asphalt).

Replacing Wheel Bearings

Replacing wheel bearings, like all things, is easy if you know how to do it. However, it's possible to ruin a wheel bearing during the installation, or to overlook wear that will cause a repeat visit. Here are the key points to remember:

- Verify the hub is true, especially if you suspect that a collision caused the bearing failure.
- Always inspect the knuckle bore and hub sleeve for wear or burrs.
- Always install retaining clips.
- Never put any load on the balls or rollers while pressing in the new bearing.
- Always install new seals and LUBRICATE them before installation.
- Always use a torque wrench to install the axle/spindle nut.
- Always use a new cotter pin or lock nut.



Ball bearings and bearing races are surface hardened, and can crack or chip if too much force is applied, like the m&m in this photo.

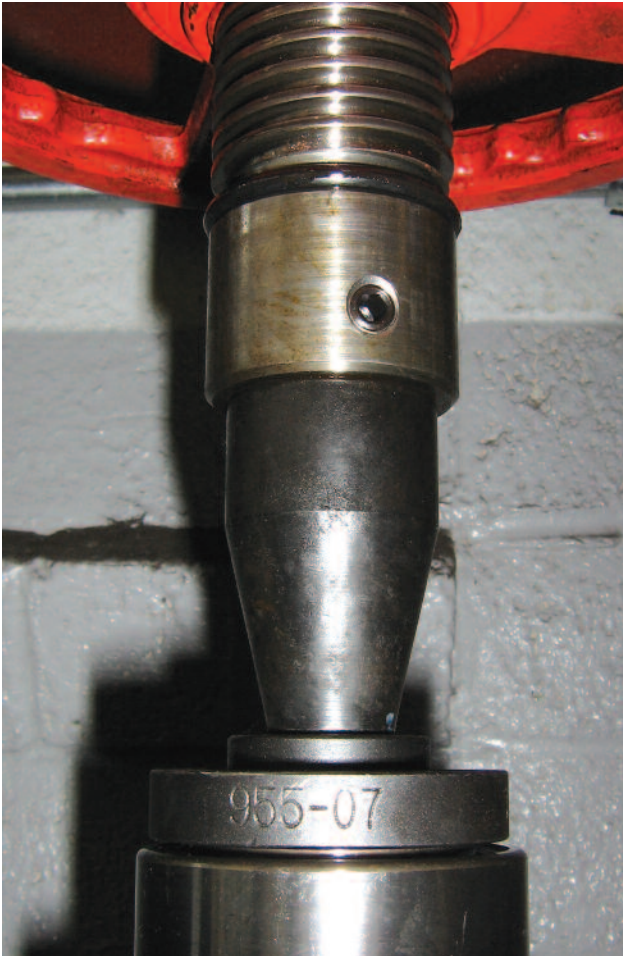

Pressing on the inner race like this will put too much pressure on the bearings and races and can cause premature failure.

Detailed bearing removal and installation instructions can be found online at nissantechinfo.com and infinitetechinfo.com, but the procedure usually goes something like this:

Pre-Removal Inspection

Check the hub face for runout. You'll find the maximum specification in the service manual, but it is typically less than .002 in. If the wheel bearing is loose, this test may not be possible.

Removal

First, let's discuss proper pressing technique. When removing the wheel bearing, putting load through the



Use an adaptor that is slightly smaller than the outer race and does not contact the inner race to press the wheel bearing into the knuckle.

bearing is okay. This is because there is no other way to press the bearing apart and **IT'S NEVER ACCEPTABLE TO REUSE A WHEEL BEARING ONCE IT HAS BEEN SEPARATED FROM THE HUB AND KNUCKLE.**

To remove the bearing:

1. Support the knuckle with a suitable tool and press the hub out of the bearing being careful not to damage the splash shield.
2. Remove the seals (if any).
3. Remove the bearing retaining clip.
4. Support the knuckle from the other side then press the wheel bearing from the knuckle.

5. Remove the inner race from the hub.
6. Throw the bearing in the scrap metal bin. It should never be used again.

Post-Removal Inspection and Dressing

The areas of the knuckle and hub that contact the bearing must be free of defects. A small pocket or recession is acceptable, but a raised area is not as it may catch and gall the surface during installation. Check the knuckle bore for burrs or galling. Remove any raised areas with a mill file or stone. Check the hub sleeve for wear. Most of the time, hub wear will be obvious once the outboard inner race is removed. When in doubt, use calipers or a micrometer. The hub sleeve should be the same diameter where both of the races ride.

Installation:

1. Some wheel bearings contain a magnetic encoder for the ABS sensor on one side and are directional; they must be installed with the encoder on the correct side. Always take a few minutes to consult the service manual before starting the job to avoid this and other pitfalls.
2. Make sure the knuckle bore and hub sleeve are clean and grit-free. Use a lint-free rag wet with acetone (brake cleaner) or rubbing alcohol. Press fit lubricant is not required, but it does make the job a bit easier. Grease or oil should not be used on the press fit surfaces.
3. Press the bearing into the knuckle **PUSHING ONLY ON THE OUTER RACE**. Pressing on the inner race can damage the bearing, causing a premature failure.
4. Install the retaining clip.
5. Lubricate the seals with wheel bearing grease and install (if applicable).
6. Press the hub into the bearing. It is important to press only on the hub and the inner race. Pressing on the hub and the knuckle will put pressure on the ball bearings, and can damage the new bearing.

Torque It!

Immediate catastrophic bearing failure caused by over-torque is not as common as it once was when

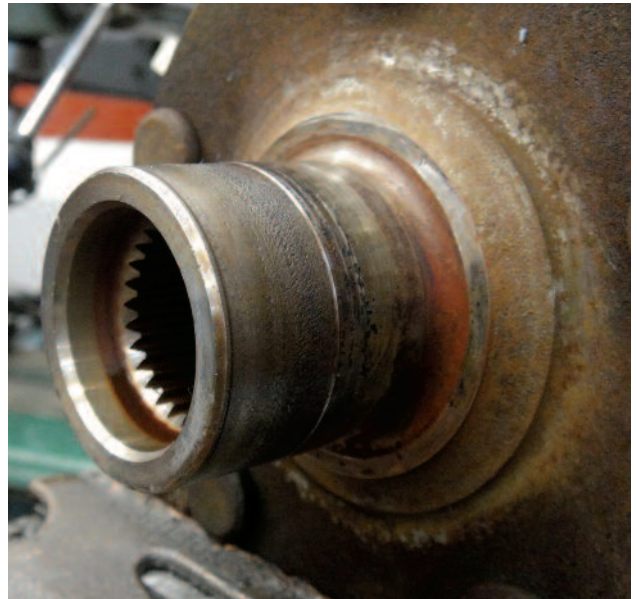

The most common problem is a seized bearing causing an inner race to spin on the hub. The race is a press fit, so if it's forced to turn, it will quickly start to gall and wear away at the hub.

taper roller bearings with user-set preload were typical. However, torque is still very important, and it's still possible to ruin a bearing with improper torque. Here's why: today's powerful impact wrenches can easily generate enough torque to compress the hub sleeve, and increase preload to the point where there is no longer any clearance left for a film of bearing grease. The bearing will in essence run dry and fail as a result. Axle nut torque specifications can vary anywhere from 80 ft.lb. to almost 200 ft.lb. Achieving the required torque with just an impact wrench cannot be done. Always use a torque wrench, and follow the thread lubrication instructions found in the service manual.

Lock It Up

Most designs will include some sort of secondary axle/spindle nut retention. The nut shouldn't back off if it is properly tightened, but since keeping the wheel on the car is a priority, one can never be too safe. Common retention methods include staking, cotter pins, and self-locking nuts. Staked nuts should be de-staked before removal to avoid damaging the axle or spindle threads, and should not be reused. Cotter pins and self-locking nuts are also one-time use. |

Nissan & Infiniti Program Dealers

ALABAMA

BESSEMER
MOORE NISSAN
205.428.6314

BIRMINGHAM
CROWN NISSAN
205.823.5266

BIRMINGHAM
JIM BURKE NISSAN
205.278.5904

FAYETTEVILLE
SUPERIOR NISSAN
479.442.4251

HUNTSVILLE
LANDERS MCCLARTY NISSAN
256.830.0266

MOBILE
PAT PECK NISSAN
251.470.5052

ALASKA

ANCHORAGE
CONTINENTAL NISSAN/ANCHOR
907.334.6230

ANCHORAGE
INFINITI OF ANCHORAGE
907.272.4022

ARIZONA

AVONDALE
AVONDALE NISSAN
888.856.3322

CHANDLER
POWER NISSAN CHANDLER
480.461.4358

MESA
COULTER INFINITI
877.415.3521

MESA
EARNHARDT'S NISSAN/SUPER
480.324.8880

MESA
LARRY H. MILLER NISSAN MESA
480.655.4060

PEORIA
INFINITI OF PEORIA
623.583.5701

PEORIA
PEORIA NISSAN
623.523.6250

PHOENIX
ABC NISSAN
602.264.3666

PHOENIX
MIDWAY NISSAN
602.866.6650

SCOTTSDALE
INFINITI OF SCOTTSDALE
480.424.3211

SCOTTSDALE
PINNACLE NISSAN
480.368.4050

TEMPE
POWER NISSAN TEMPE
480.598.6111

TUCSON
INFINITI OF TUCSON
520.690.1500

TUCSON
JIM CLICK NISSAN
520.884.4130

TUCSON
THOROUGHbred NISSAN
520.618.6500

ARKANSAS

NORTH LITTLE ROCK
NORTH LITTLE ROCK NISSAN
501.604.3955

CALIFORNIA

ALHAMBRA
ALHAMBRA NISSAN
626.289.7802

ANTIOCH
ANTIOCH NISSAN
925.281.5050

BAKERSFIELD
NISSAN OF BAKERSFIELD
661.396.4035

BAKERSFIELD
INFINITI OF BAKERSFIELD
661.617.2020

BUENA PARK
BUENA PARK NISSAN
714.739.0800

BURLINGAME
NISSAN OF BURLINGAME
650.347.4800

CARSON
CARSON NISSAN
310.221.5121

CATHEDRAL CITY
PALM SPRINGS NISSAN
760.328.2828

CERRITOS
CERRITOS INFINITI
562.405.3535

CERRITOS
CERRITOS NISSAN
800.396.7278

CHICO
CHICO NISSAN INC
530.891.0202

CITY OF INDUSTRY
PUENTE HILLS NISSAN
626.626.2600

CLOVIS
NISSAN OF CLOVIS
559.297.6919

COLMA
SERRAMONTE NISSAN
650.488.2870

CONCORD
DIRITO BROS CONCORD NISSAN
888.899.4173

CONCORD
NIELLO INFINITI
925.676.9592

CORONA
CORONA NISSAN
800.553.7438

COSTA MESA
CONNELL NISSAN
714.444.4220

DOWNEY
DOWNEY NISSAN
888.444.1355

DUARTE
PERFORMANCE NISSAN
866.540.6959

DUBLIN
DUBLIN NISSAN
952.452.8020

EL CAJON
MOSSY NISSAN EL CAJON
619.401.2068

EL MONTE
ROSS NISSAN OF EL MONTE
800.411.0554

ELK GROVE
INFINITI OF ELK GROVE
916.405.7005

ELK GROVE
NISSAN OF ELK GROVE
916.405.5010

ESCONDIDO
PERRY INFINITI
760.796.5500

ESCONDIDO
MOSSY NISSAN ESCONDIDO
760.746.5050

FAIRFIELD
MOMENTUM NISSAN
707.402.3200

FREMONT
PREMIER NISSAN OF FREMONT
510.668.8700

FONTANA
FONTANA NISSAN
909.350.8404

FRESNO
LITHIA NISSAN OF FRESNO
559.435.3500

GARDENA
GARDENA NISSAN INC
310.527.9215

GARDEN GROVE
OC NISSAN
714.537.0900

GLENDALE
GLENDALE INFINITI
818.547.0520

GLENDALE
GLENDALE NISSAN
818.547.5550

GOLETA
SANTA BARBARA NISSAN, LLC
805.964.2990

HAWTHORNE
POWER NISSAN OF SOUTH BAY
310.536.4000

HUNTINGTON BEACH
SURF CITY NISSAN
714.500.6040

IMPERIAL
ROGERS & ROGERS NISSAN
760.352.2900

IRVINE
OC NISSAN-IRVINE
800.515.4797

LA QUINTA
TORRE NISSAN
760.777.8999

LOS ANGELES
NISSAN OF DOWNTOWN L.A.
888.576.4560

LOS ANGELES
UNIVERSAL CITY NISSAN INC
818.980.0655

MISSION HILLS
NISSAN OF MISSION HILLS
818.408.5870

MISSION VIEJO
INFINITI OF MISSION VIEJO
949.916.4224

MODESTO
CENTRAL VALLEY NISSAN INC
209.526.9736

MONROVIA
METRO INFINITI
800.600.4493

MONTCLAIR
INFINITI OF MONTCLAIR
909.621.0391

NAPA
NAPA NISSAN INC
707.253.1783

NATIONAL CITY
MOSSY NISSAN NATIONAL CITY
619.263.7251

OAKLAND
NISSAN OF OAKLAND
510.588.2200

ONTARIO
EMPIRE NISSAN INC
800.994.8881

ORANGE
STADIUM NISSAN
714.633.4264

OXNARD
TEAM INFINITI
805.288.5155

OXNARD
TEAM NISSAN
805.485.2910

PALMDALE
ANTELOPE VALLEY NISSAN
661.274.9556

PETALUMA
NORTH BAY NISSAN INC
800.788.0772

REDLANDS
METRO NISSAN OF REDLANDS
888.505.9211

REDWOOD CITY
PENINSULA INFINITI LLC
650.569.4228

RICHMOND
HANLEES HILLTOP NISSAN
510.222.4900

RIVERSIDE
RIVERSIDE NISSAN
951.688.9420

RIVERSIDE
RIVERSIDE INFINITI
800.919.8130

ROSEVILLE
FUTURE NISSAN, INC
916.677.5251

ROSEVILLE
SACRAMENTO INFINITI INC
916.782.2253

SACRAMENTO
MAITA'S NISSAN SACRAMENTO
916.486.8743

SAN BERNARDINO
NISSAN OF SAN BERNARDINO
877.331.3647

SAN DIEGO
KEARNY MESA INFINITI
858.573.1755

SAN DIEGO
MOSSY NISSAN KEARNY MESA
858.565.4411

SAN DIEGO
PACIFIC NISSAN
800.365.6429

SAN JOSE
BESHOFF INFINITI
408.531.3030

SAN LEANDRO
SAN LEANDRO NISSAN
510.347.3003

SAN LUIS OBISPO
COAST NISSAN
805.786.2928

SANTA CLARA
FRONTIER INFINITI
408.243.4355

SANTA CLARA
STEVENS CREEK NISSAN
408.557.5549

SANTA CRUZ
SANTA CRUZ NISSAN
831.426.5100

SANTA MARIA
SANTA MARIA NISSAN
805.925.0077

SANTA MONICA
SANTA MONICA NISSAN INC
310.998.2262

SANTA MONICA
SANTA MONICA INFINITI
310.828.4424

SANTA ROSA
NISSAN OF SANTA ROSA
707.545.4500

SELMA
SELMA NISSAN
559.891.2896

SIMI VALLEY
FIRST NISSAN
805.526.5007

SIGNAL HILL
HOUMAN NISSAN LONG BEACH
800.973.3689

SUNNYVALE
NISSAN SUNNYVALE
408.470.4150

TEMECULA
QUALITY NISSAN/TEMECULA
951.587.3772

THOUSAND OAKS
NISSAN OF THOUSAND OAKS
888.705.4441

TORRANCE
INFINITI SOUTH BAY
310.517.0570

TUSTIN
INFINITI TUSTIN
714.832.6252

TUSTIN
TUSTIN NISSAN
714.669.8288

VALENCIA
NISSAN OF VALENCIA
866.751.0234

VAN NUYS
MILLER NISSAN INC
818.374.4493

VICTORVILLE
VALLEY HI NISSAN
888.293.7762

VISALIA
NISSAN OF VISALIA
559.741.2274

WEST COVINA
WEST COVINA NISSAN
626.388.9300

WESTMINSTER
ORANGE COAST INFINITI
714.650.8585

WESTLAKE VILLAGE
INFINITI OF THOUSAND OAKS
805.230.8262

WOODLAND HILLS
WOODLAND HILLS NISSAN
818.577.2778

COLORADO

AURORA
INFINITI OF DENVER
303.671.2596

AURORA
TYNAN'S NISSAN INC
303.341.3214

CENTENNIAL
GO NISSAN ARAPAHOE
303.790.7333

COLORADO SPRINGS
SOUTH COLO SPGS NISSAN
719.550.3041

COLORADO SPRINGS
WOODMEN NISSAN
719.234.1060

DENVER
GO NISSAN 104TH
303.738.4330

ENGLEWOOD
LARRY H. MILLER NISSAN
720.274.5243

GREELEY
EHRlich NISSAN
970.353.2065

HIGHLANDS RANCH
MIKE WARD INFINITI
303.350.4300

LAKEWOOD
EMPIRE LAKEWOOD NISSAN
303.232.3009

LITTLETON
GO NISSAN SOUTHWEST
303.738.4330

CONNECTICUT

HARTFORD
HARTE INFINITI INC
877.791.7276

HARTFORD
HARTE NISSAN INC
860.541.6942

MANCHESTER
DECORMIER MOTOR SALES INC
201.758.1756

MIDDLEBURY
COUNTY LINE BUI-NISSAN
203.758.8221

MIDDLETOWN
MIDDLETOWN NISSAN LLC
860.632.6400

MILFORD
NAPOLI NISSAN
203.877.5607

NORTH HAVEN
EXECUTIVE NISSAN
888.479.5890

SHELTON
D'ADDARIO NISSAN
800.998.6978

WEST SIMSBURY
HOFFMAN NISSAN
860.658.3340

WILTON
BRUCE BENNETT NISSAN
203.544.8371

DELAWARE

NEW CASTLE
SHERIDAN NISSAN LLC
302.326.6134

NEWARK
PORTER INFINITI
302.368.6305

NEWARK
PORTER NISSAN
302.368.6317

FLORIDA

CLEARWATER
AUTOWAY NISSAN/CLEARWATER
727.507.3200

CLEARWATER
LOKEY MOTOR COMPANY
727.374.2317

CLEARWATER
LOKEY NISSAN
727.450.7989

COCONUT CREEK
INFINITI OF COCONUT CREEK
954.861.6117

CORAL SPRINGS
CORAL SPRINGS NISSAN INC
954.752.9595

DAYTONA BEACH
DAYTONA NISSAN
386.274.6825

DELAND
DELAND NISSAN
386.734.3003

FORT LAUDERDALE
MAROONE NIS/FT LAUDERDALE
954.524.2105

FORT MYERS
SUTHERLIN NISSAN
239.267.1359

FORT PIERCE
FORT PIERCE NISSAN
772.464.4645

GAINESVILLE
GAINESVILLE NISSAN
352.378.2311

JACKSONVILLE
ATLANTIC INFINITI INC.
800.642.0200

JACKSONVILLE
COGGIN NISSAN AT THE AVE
904.886.7330

JACKSONVILLE
COGGIN NISSAN
904.642.7900

JACKSONVILLE
MIKE SHAD NISSAN/JACKSONV
866.668.8933

LAKELAND
JENKINS NISSAN INC
863.686.2800

MIAMI
BILL SEIDLE'S NISSAN INC
305.635.5478

MIAMI
ESSERMAN NISSAN LTD
305.625.6320

MIAMI
MAROONE NISSAN OF MIAMI
305.444.7868

MIAMI
WARREN HENRY INFINITI
305.654.1572

NAPLES
JOHN MARAZZI NISSAN
239.659.9000

ORLANDO
ORLANDO INFINITI
407.660.0077

ORLANDO
REED MOTORS, INC
407.297.7333

ORLANDO
SUTHERLIN NISSAN OF ORLANDO
407.657.9500

PALMETTO BAY
MAROONE NISSAN OF KENDALL
305.259.2658

PALMETTO BAY
SOUTH MOTORS INFINITI
305.256.2070

PANAMA CITY
JOHN LEE NISSAN
850.785.9561

PEMBROKE PINES
MAROONE NISSAN/PEMBROKE
954.447.2366

PENSACOLA
SANDY SANSING NISSAN INC
850.479.4777

POMPANO BEACH
POMPANO NISSAN, LLC
954.781.7700

SAINT PETERSBURG
CROWN NISSAN
727.527.8411

SARASOTA
COAST INFINITI
941.922.5723

SARASOTA
GETTEL NISSAN OF SARASOTA
941.923.1411

TALLAHASSEE
KRAFT NISSAN
850.576.6171

TAMARAC
SAVGRASS INFINITI
954.421.0669

TAMPA
AUTOWAY NISSAN OF BRANDON
813.623.1148

TAMPA
COURTESY NISSAN OF TAMPA
877.471.7658

TAMPA
INFINITI OF TAMPA
888.632.3042

ROYAL PALM BEACH
ROYAL PALM NISSAN
888.229.4132

WEST PALM BEACH
INFINITI OF PALM BEACHES
888.229.4132

WINTER HAVEN
HILL NISSAN INC
561.491.7540

GEORGIA

BOGART
NISSAN OF ATHENS
706.549.6600

BUFORD
SUTHERLIN NISSAN MALL/GEORGIA
678.714.1062

CHAMBLEE
CAPITOL CITY NISSAN LLC
770.457.4441

CONYERS
CONYERS NISSAN
770.929.8432

COLUMBUS
HEADQUARTER NISSAN
706.225.8100

DECATUR
NALLEY NISSAN
404.292.4774

DULUTH
GWINNETT PLACE NISSAN
770.813.6770

DULUTH
INFINITI OF GWINNETT
800.249.7301

GAINESVILLE
CARRIAGE NISSAN
678.717.0440

KENNESAW
TOWN CENTER NISSAN
770.423.7469

LILBURN
STONE MOUNTAIN NISSAN
678.252.3111

MACON
PAUL WALSH NISSAN INC
478.784.1991

MARIETTA
TEAM NISSAN OF MARIETTA
770.421.8639

MORROW
NISSAN SOUTH
770.968.1360

ROME
HERITAGE NISSAN
706.295.0525

ROSWELL
REGAL NISSAN INC.
770.998.8686

UNION CITY
INFINITI OF SOUTH ATLANTA
678.369.6074

UNION CITY
NISSAN SOUTH UNION CITY
770.306.9817

HAWAII

HONOLULU
INFINITI OF HONOLULU
888.836.7753

HONOLULU
NEW CITY NISSAN
808.545.3111

LIHUE
NISSAN OF KAUAI
808.245.0525

WAIPAHU
TONY NISSAN
808.680.7140

ILLINOIS

ARLINGTON HEIGHTS
ARLINGTON NISSAN/ARLINGTON
847.590.0154

BARRINGTON
MOTOR WERKS INFINITI INC
888.568.3140

CHICAGO
BERMAN'S INFINITI CHICAGO
312.476.8000

CHICAGO
MID CITY NISSAN INC.
888.635.5652

CHICAGO
WESTERN AVENUE NISSAN
773.776.8200

COUNTRYSIDE
CONTINENTAL MOTORS INC
708.354.3745

CRYSTAL LAKE
JIM M'LADY NISSAN
815.459.2296

EVANSTON
THE AUTOBARN NISSAN
800.344.3534

GLENCOE
FIELDS INFINITI
847.998.5200

GURNEE
ROSEN NISSAN OF GURNEE
847.856.0644

HIGHLAND PARK
MULLER NISSAN
847.433.7900

LIBERTYVILLE
LIBERTY IMPORT CENTER
847.680.1290

LISLE
INFINITI OF LISLE INC
866.874.6346

LOVES PARK
ANDERSON NISSAN INC
815.633.3460

MATTESON
HAWKINSON NISSAN LLC
708.720.2185

MELROSE PARK
AL PIEMONTE NISSAN INC
708.343.6669

NAPERVILLE
GERALD NISSAN, INC.
630.355.0708

MILES
STAR NISSAN INC
800.421.1947

NORTH AURORA
GERALD NISSAN OF N. AURORA
630.907.0867

O FALLON
AUFFENBERG NISSAN
618.622.4646

OAK LAWN
KELLY NISSAN INC
708.425.6659

ORLAND PARK
INFINITI OF ORLAND PARK
708.343.3800

ORLAND PARK
ORLAND PARK NISSAN INC
708.403.1673

PEORIA
UFTRING NISSAN INC
309.690.6230

SAINT CHARLES
NISSAN OF SAINT CHARLES
630.584.3900

SKOKIE
MARTIN NISSAN
847.967.2299

SOUTH HOLLAND
NISSAN OF SOUTH HOLLAND
800.696.4772

ST CHARLES
NISSAN OF ST. CHARLES
630.584.2489

WOOD RIVER
AUTOCENTERS NISSAN INC
618.251.3057

INDIANA

FISHERS
BUTLER NISSAN
866.237.0569

FORT WAYNE
FORT WAYNE NISSAN
260.484.8801

INDIANAPOLIS
ANDY MOHR NISSAN INC
317.298.2015

INDIANAPOLIS
DREYER&REINBOLD INFINITI
317.573.4291

INDIANAPOLIS
ED MARTIN NISSAN
800.731.0228

INDIANAPOLIS
HUBLER NISSAN INC
800.960.9811

INDIANAPOLIS
TOM WOOD NISSAN INC
317.688.6222

IOWA

DES MOINES
WILLIS INFINITI
800.373.1836

DES MOINES
HUMMEL'S NISSAN
515.251.8115

KANSAS

OLATHE
MCCARTHY OLATHE NISSAN
913.232.2624

KENTUCKY

LEXINGTON
GLENN NISSAN
859.263.5020

LOUISVILLE
SAM SWOPE INFINITI
877.333.3410

LOUISIANA

BATON ROUGE
ALL STAR NISSAN LLC
225.272.9330

BATON ROUGE
INFINITI OF BATON ROUGE
225.756.6199

HARVEY
RAY BRANDT NISSAN INC
504.363.1918

HOUMA
GREG LE BLANC NISSAN
985.447.1111

METAIRIE
PREMIER NISSAN/METAIRIE
504.455.5880

METAIRIE
RAY BRANDT INF/METAIRIE
504.832.2005

MAINE

SOUTH PORTLAND
BERLIN CITY NISSAN
207.774.1429

MARYLAND

ANNAPOLIS
SHEEHY INFINITI/ANNAPOLIS
888.288.5162

BALTIMORE
ANTWERPEN SECURITY NISSAN
410.298.5369

BALTIMORE
BOB BELL CHEVROLET/NISSAN
410.282.2432

BEL AIR
BEL AIR NISSAN
410.879.1133

CLARKSVILLE
ANTWERPEN NISSAN INC
866.226.4930

ELLCOTT CITY
NORRIS NISSAN WEST
443.549.1260

FREDERICK
FREDERICK NISSAN
301.662.4800

GRISMANTOWN
CRISWELL NISSAN
301.670.3900

GLEN BURNIE
SHEEHY NISSAN
877.478.3539

LAUREL
TISCHER NISSAN
800.288.6983

MARLOW HEIGHTS
PASSPORT NIS/MARLOW HEIGHTS
301.423.8400

ROCKVILLE
DARCARS NISSAN
301.309.2200

SALISBURY
POHANKA NISSAN/SALISBURY
410.548.4704

SILVER SPRING
HERB GORDON NISSAN
301.890.3055

TIMONIUM
NATIONWIDE MOTOR SLS CORP
410.252.5834

WALDORF
SHEEHY NISSAN OF WALDORF
301.843.5300

MASSACHUSETTS

AUBURN
BERTERA NISSAN INC
508.832.9611

BEVERLY
ROLAND D. KELLY NISSAN
978.767.4816

BROCKTAN
NISSAN 24
508.588.9520

BOURNE
NISSAN OF BOURNE
508.759.4400

DANVERS
KELLY INFINITI
866.883.7093

HYANNIS
BALISE NISSAN OF CAPE COD
508.771.3636

LANCASTER
RON BOUCHARD'S NISSAN
978.345.1800

LYNNFIELD
KELLY NISSAN OF LYNNFIELD
866.979.4250

MEDFORD
COLONIAL NISSAN
781.395.5300

MILFORD
MILFORD NISSAN
508.422.2800

NORTH ATTLEBORO
NISSAN VILLAGE
888.309.0980

NORWOOD
INFINITI AUTO OF NORWOOD
888.340.4442

RAYNHAM
MASTRIA NISSAN, INC
800.248.2458

TEWKSBURY
IRA NISSAN TEWKSBURY
978.746.2500

WEST SPRINGFIELD
JERRY ROME NISSAN
413.746.2269

MICHIGAN

FARMINGTON HILLS
SUBURBAN NISSAN / FARM HILL
800.242.8425

GRAND RAPIDS
PFEIFFER INFINITI INC
616.940.8992

KALAMAZOO
COLE NISSAN
269.342.9800

KENTWOOD
FOX NISSAN/GRAND RAPIDS
616.719.5750

NOVI
SUBURBAN INFINITI INC
800.242.8425

OKEMOS
LANISING NISSAN
517.827.0273

TRAVERSE CITY
TRAVERSE CITY AUTO PLAZA
800.852.6475

TROY
SUBURBAN INFINITI OF TROY
248.731.3400

TROY
SUBURBAN NISSAN OF TROY
248.649.2074

MINNESOTA

BLOOMINGTON
FELDMANN IMPORTS INC
952.837.6350

BLOOMINGTON
LUTHER INF OF BLOOMINGTON
952.885.7050

BROOKLYN PARK
BROOKLYN PARK AUTOMOTIVE
763.765.1562

BURNSVILLE
WALSER NISSAN
952.898.7306

GOLDEN VALLEY
JIM LUPIENT INFINITI
763.513.4715

INVER GROVE HEIGHTS
LUTHER NISSAN
800.246.9984

MAPLEWOOD
KLINE NISSAN
651.379.4325

MISSISSIPPI

BRANDON
GRAY-DANIELS NISSAN BRAND
800.530.7989

GULFPORT
PAT PECK NISSAN
228.864.6411

HATTIESBURG
PETRO AUTOMOTIVE GROUP
601.264.4411

JACKSON
GRAY-DANIELS NISSAN NORTH
601.899.7450

TUPELO
CARLOCK NISSAN OF TUPELO
800.808.6481

MISSOURI

BALLWIN
WEST COUNTY NISSAN
866.536.4795

COLUMBIA
JOE MACHENS NISSAN
573.443.1660

CREVE COEUR
PLAZA INFINITI
314.301.1702

HAZELWOOD
BOMMARITO NISSAN INC
314.731.8270

KANSAS CITY
RANDY REED NISSAN LLC
816.459.4800

KANSAS CITY
STATE LINE NISSAN
816.942.4007

SAINT LOUIS
LOU FUSZ MOTOR COMPANY
800.392.1372

SAINT LOUIS
SUNTRUP NISSAN VOLKSWAGEN
314.892.8200

SPRINGFIELD
INFINITI OF SPRINGFIELD
417.616.5581

MONTANA

BILLINGS
BILLINGS NISSAN LLC
406.294.1259

MISSOULA
MISSOULA NISSAN-HYUNDAI
406.721.1100

NEBRASKA

OMAHA
NISSAN OF OMAHA LLC
402.493.1945

NEVADA

HENDERSON
HENDERSON NISSAN
702.558.5974

LAS VEGAS
DESERT NISSAN
702.262.0540

LAS VEGAS
PLANET NISSAN
702.839.6138

LAS VEGAS
TOWBIN INFINITI
702.252.8134

LAS VEGAS
UNITED NISSAN
702.207.8032

NEW HAMPSHIRE

MANCHESTER
TEAM NISSAN INC
603.634.4442

NASHUA
INFINITI OF NASHUA
603.888.2446

NASHUA
PETER'S AUTO SALES INC
603.579.5205

NEW JERSEY

AVENEL
SANSONE'S ROUTE 1 NISSAN
732.815.2525

BLOOMFIELD
LYNNES NISSAN CITY INC
973.743.8387

BUTLER
ROUTE 23 NISSAN LLC
888.393.4861

CHERRY HILL
CHERRY HILL NISSAN INC
856.667.8010

CLIFTON
FETTE INFINITI, LLC
973.743.3100

ENGLEWOOD
INFINITI OF ENGLEWOOD LLC
800.969.2204

FLEMINGTON
FLEMINGTON INFINITI
800.218.1437

FLEMINGTON
FLEMINGTON NISSAN
800.381.9113

FREEHOLD
DCH FREEHOLD NISSAN
732.780.4660

HAINESPORT
CLASSIC CARS NISSAN
609.267.2886

HASBROUCK HEIGHTS
MEADOWLANDS NISSAN
888.935.7799

KEYPORT
PINE BELT NISSAN/KEYPORT
732.264.4364

MAPLE SHADE
HOLMAN INFINITI
800.523.0285

NEPTUNE
SANSONE JR'S 66 NISSAN
800.274.7121

JERSEY CITY
HUDSON NISSAN
201.435.2003

NORTH PLAINFIELD
NORTH PLAINFIELD NISSAN
800.311.4663

SOMERVILLE
SOMERSET NISSAN
908.722.3600

SOUTH BRUNSWICK
ACME NISSAN
800.367.0269

STANHOPE
LYNNES NISSAN WEST INC
800.245.9590

TOMS RIVER
PINE BELT AUTOMOTIV INC
732.349.6878

TURNERSVILLE
NISSAN OF TURNERSVILLE
800.883.0003

WOODBURY
WOODBURY NISSAN INC
856.853.8176

NEW MEXICO

ALBUQUERQUE
GARCIA INFINITI
505.217.3002

ALBUQUERQUE
MELLOY NISSAN
505.266.8588

ALBUQUERQUE
RELIABLE NISSAN
505.897.6001

NEW YORK

ALBANY
ARMORY NISSAN INC
518.641.7672

AMHERST
MIKE BARNEY NISSAN
716.833.6618

BAYSIDE
STAR NISSAN INC.
718.359.7454

BLAUVELT
ROCKLAND NISSAN
845.358.3670

BROOKLYN
BAY RIDGE NISSAN INC.
718.238.4776

BROOKLYN
KING'S NISSAN INC
718.934.3900

BROOKLYN
KINGS INFINITI INC
718.646.3335

COHOES
LIA INFINITI
518.738.0800

GREAT NECK
GREAT NECK NISSAN
516.301.5155

KINGSTON
KINGSTON NISSAN
845.338.3100

OZONE PARK
NISSAN OF QUEENS
877.259.2886

GREENVALE
BARON NISSAN INC
516.621.2299

HUNTINGTON STATION
NISSAN OF HUNTINGTON
631.439.7000

JACKSON HEIGHTS
KOEPEL NISSAN INC
718.898.7800

LYNBROOK
LEGACY INFINITI LTD
877.569.4634

MANHASSET
INFINITI OF MANHASSET
866.382.2266

MOUNT KISCO
JIM HARTE NISSAN
914.2423990

NEW YORK
INFINITI OF MANHATTAN INC
212.315.0700

PATCHOGUE
NISSAN 112 SALES CORP
631.289.9070

PORT CHESTER
NISSAN CITY/PORT CHESTER
914.937.1777

RIVERHEAD
RIVERHEAD AUTO MALL LTD
631.369.0111

SAINT JAMES
SMITHTOWN NISSAN, INC
631.361.9560

SCHENECTADY
LIA NISSAN
518.370.2121

SEAFORD
MASSAPEQUA NISSAN
631.842.5320

STATEN ISLAND
S.G. HYLAN MOTORS CORP
718.447.3800

SYOSSET
LEGEND NISSAN LTD
516.496.7385

WEST ISLIP
ATLANTIC NISSAN SUPERSTOR
631.587.2766

WESTBURY
ADVANTAGE NISSAN
516.935.1813

WHITE PLAINS
PEPE INFINITI INC
800.344.7660

YONKERS
CENTRAL AVENUE NISSAN
914.961.3900

YORKTOWN HEIGHTS
CURRY NISSAN
914.737.3500

NORTH CAROLINA

CARY
LEITH NISSAN
919.589.0029

CHARLOTTE
EAST CHARLOTTE NISSAN
704.535.4012

CHARLOTTE
SOUTH CHARLOTTE NISSAN
704.552.9191

CORNELIUS
LAKE NORMAN INFINITI
704.237.5100

CORNELIUS
MODERN NISSAN/LAKE NORMAN
704.237.8008

DURHAM
MICHAEL JORDAN NISSAN
919.489.3800

GREENSBORO
CROWN NISSAN
866.525.9859

GREENSBORO
MODERN INFINITI LLC
888.232.4118

HICKORY
CROSSROADS NISSAN
828.324.5040

MATTHEWS
INFINITI OF CHARLOTTE
704.815.1018

RALEIGH
CROSSROADS INFINITI INC
919.981.5656

RALEIGH
SOUTHERN STATES NISSAN
888.998.0044

SANFORD
CROSSROADS NISSAN
877.399.4830

STATESVILLE
CLASSIC NISSAN
704.872.8500

WAKE FOREST
CROSSROADS NISSAN
919.435.5740

WILMINGTON
CAPITAL NISSAN
910.392.4300

WINSTON SALEM
MODERN INF/WINSTON-SALEM
888.232.4118

WINSTON-SALEM
MODERN NISSAN LLC
336.744.2142

OHIO

BEDFORD
INFINITI OF BEDFORD
440.359.1453

CINCINNATI
INFINITI OF CINCINNATI
513.583.1200

COLUMBUS
GERMAIN NISSAN
614.418.4506

CUYAHOGA FALLS
RON MARHOFFER NISSAN
330.923.8000

DAYTON
MATT CASTRUCCI NISSAN
800.952.4604

DUBLIN
INFINITI OF COLUMBUS LLC
614.793.2481

HILLIARD
BUCKEYE NISSAN INC.
614.771.2370

LIMA
REINEKE NISSAN
419.227.7400

MAYFIELD HEIGHTS
GANLEY NISSAN
440.449.9500

MEDINA
KEN GANLEY NISSAN INC.
330.721.0509

MENTOR
MENTOR NISSAN
440.951.1100

STREETSBORO
CLASSIC NISSAN
330.422.7300

TOLEDO
YARK NISSAN
419.842.7532

OKLAHOMA

BROKEN ARROW
NELSON NISSAN
800.364.4600

OKLAHOMA CITY
BOB HOWARD NISSAN INC
405.943.9555

OKLAHOMA CITY
BOB MOORE INFINITI INC
405.748.6086

OKLAHOMA CITY
HUDIBURG NISSAN L.L.C.
405.632.0715

TULSA
BOB MOORE NISSAN OF TULSA
918.628.1495

TULSA
JACKIE COOPER NISSAN
888.211.6202

OREGON

EUGENE
LITHIA NISSAN OF EUGENE
541.686.2218

GLADSTONE
GLADSTONE NISSAN
503.723.2070

GRESHAM
GRESHAM NISSAN SUBARU INC
503.661.5812

MEDFORD
LITHIA NISSAN
541.774.8416

PORTLAND
BEAVERTON INFINITI
503.526.5302

PENNSYLVANIA

ARDMORE
INFINITI OF ARDMORE
610.896.4400

ALLENTOWN
ROTHROCK MOTOR SALES INC
484.223.0596

BEAVER FALLS
BEAVER COUNTY NISSAN
724.847.4800

CONCORDVILLE
CONCORDVILLE NISSAN
610.459.9135

CONSHOHOCKEN
CONICELLI NISSAN
800.845.0999

DEVON
NISSAN OF DEVON
610.695.2900

DOYLESTOWN
FRED BEANS NISSAN/DOYLEST
888.842.8829

ERIE
PORRECO NISSAN INC
814.860.8377

EXTON
EXTON NISSAN
610.594.7400

FAIRLESS HILLS
PERUZZI NISSAN
215.949.6970

FEASTERTVILLE
COLONIAL NISSAN INC
215.364.1800

JENKINTOWN
FAULKNER NISSAN
215.887.7940

MECHANICSBURG
BRENNER NISSAN
717.697.8400

MONTGOMERYVILLE
MONTGOMERYVILLE NISSAN
888.430.2929

MOON TOWNSHIP
WEST HILLS NISSAN
412.262.1403

MUNCY
ALEXANDER NISSAN INC.
570.546.4925

PHILADELPHIA
CHAPMAN NISSAN LLC
215.492.8900

PITTSBURGH
COCHRAN NISSAN/SOUTH HILL
412.343.3200

PITTSBURGH
PITTSBURGH EAST NISSAN
412.823.0101

PLEASANT HILLS
BOWSER NISSAN
888.455.2377

SCRANTON
TOM HESSER NISSAN
570.558.2000

STATE COLLEGE
NISSAN OF STATE COLLEGE
814.238.2447

WEST CHESTER
INFINITI OF WEST CHESTER
484.885.2275

WEXFORD
WRIGHT AUTOMOTIVE GROUP
724.935.4646

WILLOW GROVE
INFINITI OF WILLOW GROVE
215.784.9320

YORK
APPLE NISSAN INC.
717.755.9543

RHODE ISLAND

WARWICK
INFINITI OF WARWICK
401.824.2225

WEST WARWICK
NISSAN WEST WARWICK
401.824.2364

SOUTH CAROLINA

CHARLESTON
BAKER INFINITI CHARLESTON
843.852.4029

CHARLESTON
MORRIS MOTORS INC
843.571.2810

COLUMBIA
DICK SMITH NISSAN
800.922.6218

GREENVILLE
CROWN NISSAN GREENVILLE
864.254.7711

GREER
NISSAN OF GREER
864.868.6615

HARDEEVILLE
INFINITI OF HILTONHEAD
800.501.7408

HARDEEVILLE
KEY NISSAN LLC
800.868.6615

TENNESSEE

ALCOA
TWIN CITY NISSAN
865.970.4132

BARTLET
WOLFCHASE NISSAN
901.255.3880

CHATTANOOGA
KELLY INF. OF CHATTANOOGA
423.899.8934

CLARKSVILLE
HAROLD MATHEWS NISSAN
931.221.4230

FRANKLIN
NISSAN OF COOL SPRINGS
877.250.7778

JACKSON
CARLOCK NISSAN OF JACKSON
800.200.3997

JOHNSON CITY
TRI-CITIES NISSAN INC
423.952.1920

KNOXVILLE
HARPER INFINITI INC
877.870.8052

MEMPHIS
DOBBS NISSAN
901.759.6100

MEMPHIS
JIM KERAS NISSAN INC
901.373.2800

NASHVILLE
DOWNTOWN NASHVILLE NISSAN
615.248.5110

SHELBYVILLE
VICTORY NISSAN SOUTH
931.488.3286

TEXAS

ARLINGTON
DON DAVIS NISSAN INC
817.588.5510

AUSTIN
AUSTIN INFINITI INC.
512.454.6338

AUSTIN
SOUTH POINT NISSAN
512.444.4962

AUSTIN
TOWN NORTH NISSAN
800.251.7278

BEDFORD
GRUBBS NISSAN
817.268.8930

CONROE
STREATER-SMITH NISSAN
936.523.2142

CORINTH
ORR NISSAN OF CORINTH
866.360.4763

CORPUS CHRISTI
ED HICKS NISSAN LTD
361.654.8561

DALLAS
CLAY COOLEY NISSAN
972.709.2000

EL PASO
CASA NISSAN INC
915.779.3261

EL PASO
HOY-FOX INFINITI
915.772.3256

EULESS
GRUBBS INFINITI LTD
817.359.4114

FORT WORTH
NISSAN OF FORT WORTH
817.696.4886

GRAPEVINE
TEXAS NISSAN OF GRAPEVINE
817.601.3563

GREENVILLE
ORR NISSAN
903.454.1930

HOUSTON
BAKER NISSAN NORTH
281.890.5656

HOUSTON
BAKER NISSAN SOUTH
713.349.6174

HOUSTON
CLEAR LAKE INFINITI
713.589.4013

HOUSTON
MCDAVID NISSAN
713.941.0400

HOUSTON
MOSSY NISSAN
281.589.5309

HOUSTON
SOUTHWEST INFINITI
713.981.5812

HOUSTON
TOM PEACOCK NISSAN
832.626.1425

HUMBLE
ROBBINS NISSAN
281.446.3181

IRVING
BANKSTON NISSAN OF IRVING
972.438.4848

LEAGUE CITY
CLEAR LAKE NISSAN
281.557.5450

LEWISVILLE
BANKSTON NISSAN LEWISVILLE
972.353.0270

LONGVIEW
PATTERSON NISSAN/LONGVIEW
903.758.4135

MCALEN
BERT OGDEN NISSAN
956.631.6666

MCKINNEY
NISSAN OF MCKINNEY
866.742.0297

MESQUITE
TROPHY NISSAN
866.831.2622

PLANO
CREST INFINITI
972.516.2314

RICHARDSON
COURTESY NISSAN
972.644.3942

ROUND ROCK
ROUND ROCK NISSAN
512.244.8525

SAN ANTONIO
ANCIRA NISSAN INC
800.508.1117

SAN ANTONIO
GUNN INFINITI LTD
210.824.6152

SAN ANTONIO
GUNN NISSAN LTD.
210.494.4760

SAN ANTONIO
INGRAM PARK NISSAN
210.681.6017

TYLER
PELTIER NISSAN
903.534.8934

WEATHERFORD
SOUTHWEST NISSAN
817.565.1170

UTAH
MURRAY
TIM DAHLE INFINITI
800.848.4070

MURRAY
TIM DAHLE NISSAN
801.269.6420

RIVERDALE
KEN GARFF NISSAN RIVERDAL
801.627.6762

SALT LAKE CITY
KEN GARFF NISSAN OF SALT LAKE
800.888.1926

VERMONT

SOUTH BURLINGTON
FREEDOM NISSAN INC
802.846.0210

VIRGINIA

ALEXANDRIA
PASSPORT INFINITI/ALEXAND
703.461.1500

CHANTILLY
INFINITI OF CHANTILLY
703.322.3629

CHANTILLY
NISSAN OF CHANTILLY
800.724.9350

CHARLOTTESVILLE
COLONIAL NISSAN-PONT-CAD
434.951.1062

CHESAPEAKE
HALL NISSAN CHESAPEAKE
866.401.8332

CHESAPEAKE
NISSAN OF CHESAPEAKE
800.558.9924

CHESTER
PRIORITY NISSAN RICHMOND
804.518.1888

CHRISTIANSBURG
NEW RIVER NISSAN INC
540.382.9697

FAIRFAX
BROWN'S FAIRFAX NISSAN
703.591.8009

FALLS CHURCH
KOONS NISSAN
703.241.1000

FOREST
LYNCHBURG NISSAN INC
434.385.7733

HAMPTON
POMOCO NISSAN OF HAMPTON
757.838.6111

MANASSAS
SHEEHY NISSAN OF MANASSAS
703.361.0377

MECHANICSVILLE
SHEEHY NISSAN
804.417.1012

MIDLOTHIAN
PENCE NISSAN
804.527.0300

NEWPORT NEWS
NISSAN OF NEWPORT NEWS
757.369.6600

NORFOLK
CHARLES BARKER NISSAN
757.353.4878

RICHMOND
PEARSON INFINITI
804.527.0300

RICHMOND
SHEEHY NISSAN OF RICHMOND
804.346.4200

ROANOKE
FIRST TEAM NISSAN
540.362.4800

SPRINGFIELD
SHEEHY NISSAN/SPRINGFIELD
703.922.2223

STERLING
BROWN'S STERLING NISSAN
703.948.1100

VIENNA
INFINITI OF TYSONS CORNER
800.441.1291

VIRGINIA BEACH
CHARLES BARKER INFINITI
757.818.9553

VIRGINIA BEACH
HALL NISSAN VIRGINIA BEACH
866.930.7644

WOODBRIIDGE
COWLES NISSAN
866.830.1688

WASHINGTON

BELLEVUE
NISSAN OF THE EASTSIDE
425.462.9074

EVERETT
MAGIC NISSAN OF EVERETT
425.347.5763

FIFE
INFINITI/TACOMA AT FIFE
253.231.4310

KIRKLAND
INFINITI OF KIRKLAND
425.602.7205

OLYMPIA
OLYMPIA NISSAN
888.713.0195

RENTON
YOUNKER NISSAN
425.251.8107

SEATTLE
STADIUM NISSAN OF SEATTLE
206.623.1261

SPOKANE
WENDLE NISSAN
509.468.4047

TACOMA
BRUCE TITUS TACOMA NISSAN
253.473.6200

TACOMA
TACOMA NISSAN
253.579.1200

WISCONSIN

GREEN BAY
GANDRUD NISSAN
800.242.2844

MADISON
ZIMBRICK INFINITI MADISON
608.277.2277

MADISON
ZIMBRICK NISSAN
608.241.1122

MILWAUKEE
ROSEN NISSAN INC
800.333.0149

Trust the Original, Use Genuine Nissan/Infiniti Parts.

WHAT'S STOPPING YOU?

GIVE YOUR CUSTOMERS WHAT THEY WANT.

Introducing the new Nissan Value Advantage™ Brake Pad. No aftermarket competitors have the advantage of being manufacturer tested and validated by Nissan engineers, yet pricing of Value Advantage Brake Pads remains highly competitive with aftermarket products.

Improve Customer Satisfaction with the Nissan Value Advantage:

- True Premium Ceramic Pad Make-up
- Precision Steel backing plates
- Precision fit shims included

See your local Nissan Dealer for details.



SHIFT. the way you move



Nissan and the Nissan Brand Symbol are Nissan Trademarks.
©2011 Nissan North America, Inc.

VALUE ADVANTAGE™